

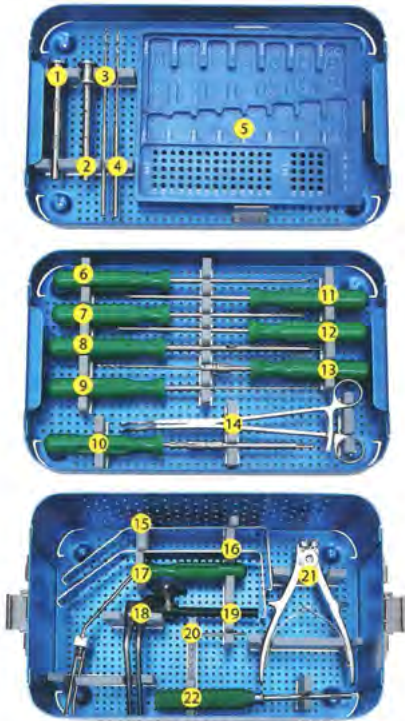

Implants | International

A D @ 5 B H G
B H 9 F B 5 H = C B 5 @
B G H F I A 9 B H G G 9 H
7 5 H 5 @ C ; I 9

Anterior Cervical Plate System Instrument Set



| | | | |
|----|-----------|----------------------------|---|
| 1 | 2200-0201 | Screwdriver Sleeve | 1 |
| 2 | 2200-0202 | Screwdriver Sleeve | 1 |
| 3 | 2200-0203 | Drill Bit | 1 |
| 4 | 2200-0204 | Drill Bit | 1 |
| 5 | 2200-0205 | Plate and Screw Box | 1 |
| 6 | 2200-0206 | Curette | 1 |
| 7 | 2200-0207 | Hex Screwdriver | 1 |
| 8 | 2200-0208 | Brace Screwdriver | 1 |
| 9 | 2200-0209 | AWL | 1 |
| 10 | 2200-0210 | Tap | 1 |
| 11 | 2200-0211 | Nut Screwdriver | 1 |
| 12 | 2200-0212 | Hex Screwdriver | 1 |
| 13 | 2200-0213 | Hex Screwdriver | 1 |
| 14 | 2200-0214 | Plate Holding Forcecp | 1 |
| 15 | 2200-0215 | Cervical Hook | 1 |
| 16 | 2200-0216 | Cervical Hook | 1 |
| 17 | 2200-0217 | Guider | 1 |
| 18 | 2200-0218 | Distracter | 1 |
| 19 | 2200-0219 | Brace Screw | 1 |
| 20 | 2200-0220 | Location Screw | 4 |
| 21 | 2200-0221 | Plate Bender | 1 |
| 22 | 2200-0222 | Location Screw Screwdriver | 1 |
| 23 | 2200-0223 | Aluminium Box | 1 |

Posterior Cervical Fixation System Instrument Set

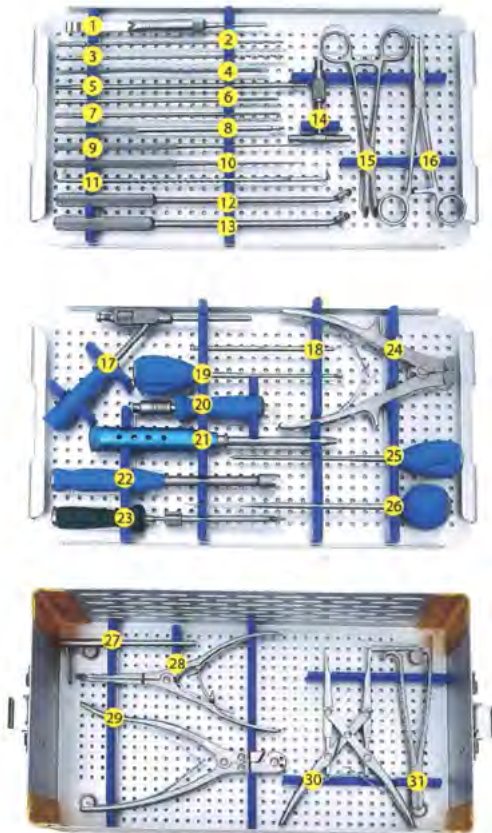

| | | | |
|----|-----------|-----------------------------------|---|
| 1 | 2200-0301 | Depth Gauge 0-40mm | 1 |
| 2 | 2200-0302 | Drill Bit 2.7mm | 1 |
| 3 | 2200-0303 | Drill Bit 2.4mm | 1 |
| 4 | 2200-0304 | Trail Rod | 1 |
| 5 | 2200-0305 | Screwdriver Hexagonal 2.5mm | 1 |
| 6 | 2200-0306 | Tap ϕ 4.0 | 1 |
| 7 | 2200-0307 | Tap ϕ 3.5 | 1 |
| 8 | 2200-0308 | Nut Holder | 1 |
| 9 | 2200-0309 | Feeler for Screw Channel Bent | 1 |
| 10 | 2200-0310 | Feeler for Screw Channel Straight | 1 |
| 11 | 2200-0311 | Distracter | 1 |
| 12 | 2200-0312 | In-situ Bending Iron L | 1 |
| 13 | 2200-0313 | In-situ Bending Iron R | 1 |
| 14 | 2200-0314 | T-handle Quick Coupling | 1 |
| 15 | 2200-0315 | Hook Holding Forcecp | 1 |
| 16 | 2200-0316 | Rod Holding Forcecp | 1 |
| 17 | 2200-0317 | Guider | 1 |
| 18 | 2200-0318 | Screwdriver Hexagonal 2.5mm | 1 |
| 19 | 2200-0319 | Rod Pushing Forcecp | 1 |
| 20 | 2200-0320 | Straight Handle Quick Coupling | 1 |
| 21 | 2200-0321 | Insert Device for Fixation Pin | 1 |
| 22 | 2200-0322 | Counter Torque | 1 |
| 23 | 2200-0323 | Screwdriver for Polyaxial Screw | 1 |
| 24 | 2200-0324 | Rod Bender | 1 |
| 25 | 2200-0325 | AWL | 1 |
| 26 | 2200-0326 | AWL | 1 |
| 27 | 2200-0327 | Protection Sleeve | 1 |
| 28 | 2200-0328 | Distraction Forcecp | 1 |
| 29 | 2200-0329 | Rod Cutter | 1 |
| 30 | 2200-0330 | Parallel Compression Forcecp | 1 |
| 31 | 2200-0331 | Rod Twist | 1 |
| 32 | 2200-0332 | Aluminium Box | 1 |

Anterior Thoracic & Thoracolumbar Plate Instrument Set

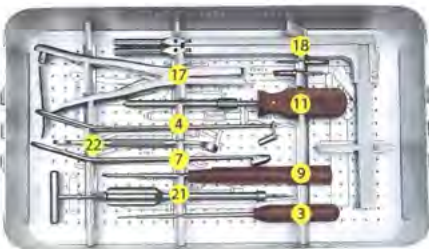
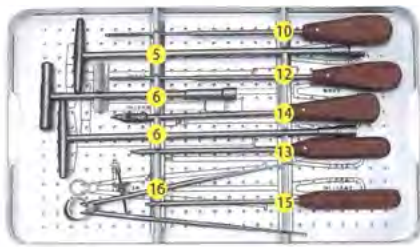
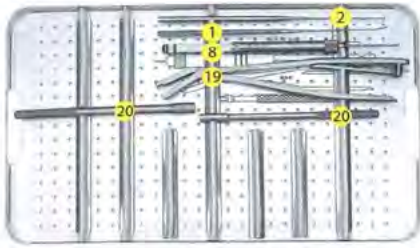

| | | |
|----|-----------|-----------------------|
| 1 | 2200-0401 | Curved Guide Pin |
| 2 | 2200-0402 | Straight Guide Pin |
| 3 | 2200-0403 | Drill Bit |
| 4 | 2200-0404 | Obturator |
| 5 | 2200-0405 | Nut Driver SW8 |
| 6 | 2200-0406 | Nut Driver SW8 |
| 7 | 2200-0407 | Drill Guider |
| 8 | 2200-0408 | Detector |
| 9 | 2200-0409 | Hole Enlarger |
| 10 | 2200-0410 | Tap 6.5mm |
| 11 | 2200-0411 | Screw Holding Driver |
| 12 | 2200-0412 | Tap 6mm |
| 13 | 2200-0413 | Screwdriver |
| 14 | 2200-0414 | Universal Screwdriver |
| 15 | 2200-0415 | Screwdriver |
| 16 | 2200-0416 | Calipers |
| 17 | 2200-0417 | Compression Clamp 3mm |
| 18 | 2200-0418 | Distractor Clamp |
| 19 | 2200-0419 | Plate Holding Clamp |
| 20 | 2200-0420 | Holding Bolt SW8 |
| 21 | 2200-0421 | Combination Wrench |
| 22 | 2200-0422 | Wrench SW11 |
| 23 | 2200-0423 | Aluminium Box |

Titanium Mesh Cage Instrument Set

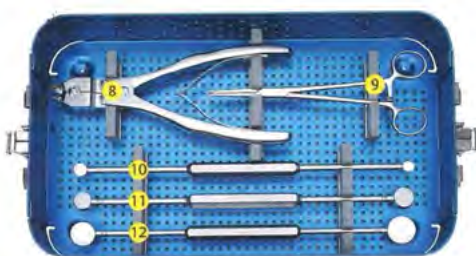

| | | |
|----|-----------|-----------------------|
| 1 | 2200-0401 | Curved Guide Pin |
| 2 | 2200-0402 | Straight Guide Pin |
| 3 | 2200-0403 | Drill Bit |
| 4 | 2200-0404 | Obturator |
| 5 | 2200-0405 | Nut Driver SW8 |
| 6 | 2200-0406 | Nut Driver SW8 |
| 7 | 2200-0407 | Drill Guider |
| 8 | 2200-0408 | Detector |
| 9 | 2200-0409 | Hole Enlarger |
| 10 | 2200-0410 | Tap 6.5mm |
| 11 | 2200-0411 | Screw Holding Driver |
| 12 | 2200-0412 | Tap 6mm |
| 13 | 2200-0413 | Screwdriver |
| 14 | 2200-0414 | Universal Screwdriver |
| 15 | 2200-0415 | Screwdriver |
| 16 | 2200-0416 | Calipers |
| 17 | 2200-0417 | Compression Clamp 3mm |
| 18 | 2200-0418 | Distractor Clamp |
| 19 | 2200-0419 | Plate Holding Clamp |
| 20 | 2200-0420 | Holding Bolt SW8 |
| 21 | 2200-0421 | Combination Wrench |
| 22 | 2200-0422 | Wrench SW11 |
| 23 | 2200-0423 | Aluminium Box |

Cervical Peek Cage Instrument Set

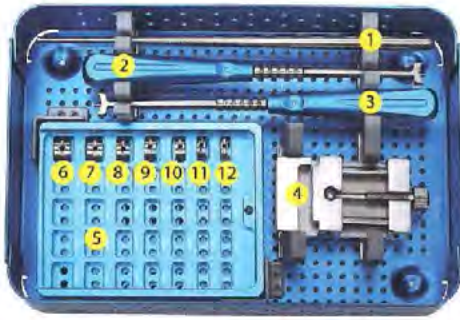

| | | | |
|----|-----------|---------------------|---|
| 1 | 2200-0601 | Bone Graft Inserter | 1 |
| 2 | 2200-0602 | Trail Holder | 1 |
| 3 | 2200-0603 | Peek Cage Holder | 1 |
| 4 | 2200-0604 | Bone Graft Cage | 1 |
| 5 | 2200-0605 | Cage Box | 1 |
| 6 | 2200-0606 | Trail 10mm | 1 |
| 7 | 2200-0607 | Trail 9mm | 1 |
| 8 | 2200-0608 | Trail 8mm | 1 |
| 9 | 2200-0609 | Trail 7mm | 1 |
| 10 | 2200-0610 | Trail 6mm | 1 |
| 11 | 2200-0611 | Trail 5mm | 1 |
| 12 | 2200-0612 | Trail 4mm | 1 |
| 13 | 2200-0613 | Aluminium Box | 1 |

PLIF Peek Cage & Lumbar Titanium Cage

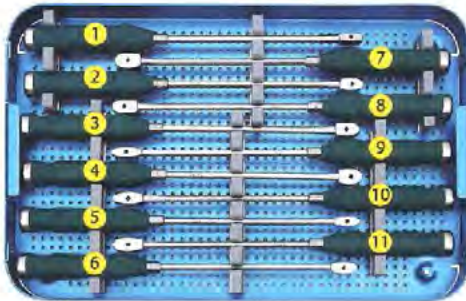

| | | | |
|----|-----------|---------------------|---|
| 1 | 2200-0601 | Bone Graft Inserter | 1 |
| 2 | 2200-0602 | Trail Holder | 1 |
| 3 | 2200-0603 | Peek Cage Holder | 1 |
| 4 | 2200-0604 | Bone Graft Cage | 1 |
| 5 | 2200-0605 | Cage Box | 1 |
| 6 | 2200-0606 | Trail 10mm | 1 |
| 7 | 2200-0607 | Trail 9mm | 1 |
| 8 | 2200-0608 | Trail 8mm | 1 |
| 9 | 2200-0609 | Trail 7mm | 1 |
| 10 | 2200-0610 | Trail 6mm | 1 |
| 11 | 2200-0611 | Trail 5mm | 1 |
| 12 | 2200-0612 | Trail 4mm | 1 |
| 13 | 2200-0613 | Aluminium Box | 1 |

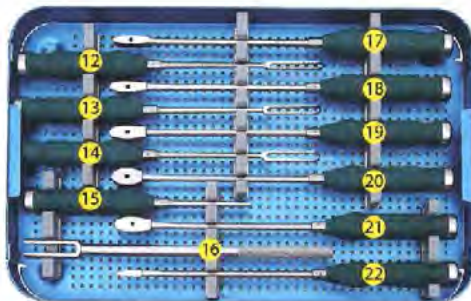

TLIF Peek Cage Instrument Set

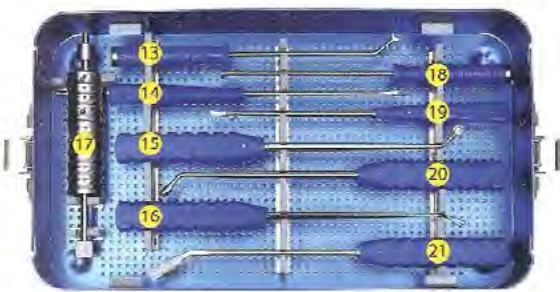
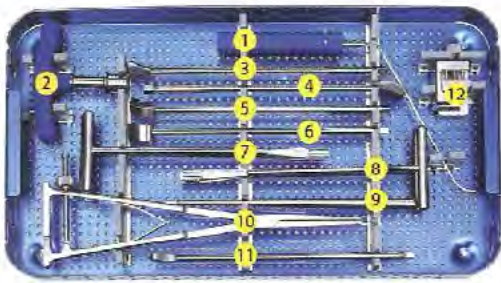

| | | | |
|----|-----------|-------------------------|---|
| 1 | 2200-0801 | Insert Guider | 1 |
| 2 | 2200-0802 | T-handle Quick Coupling | 1 |
| 3 | 2200-0803 | Trial 7*25mm | 1 |
| 4 | 2200-0804 | Trial 9*25mm | 1 |
| 5 | 2200-0805 | Trial 11*25mm | 1 |
| 6 | 2200-0806 | Trial 13*25mm | 1 |
| 7 | 2200-0807 | Flat Reamer 7mm | 1 |
| | 2200-0808 | Flat Reamer 9mm | 1 |
| 8 | 2200-0809 | Flat Reamer 11mm | 1 |
| | 2200-0810 | Flat Reamer 13mm | 1 |
| 9 | 2200-0811 | Bone Graft Inserter | 1 |
| 10 | 2200-0812 | Cage Holding Forcecp | 1 |
| 11 | 2200-0813 | Trial 15*25mm | 1 |
| 12 | 2200-0814 | Bone Graft Cage | 1 |
| 13 | 2200-0815 | Curved Implanter | 1 |
| 14 | 2200-0816 | Side Curette 6mm | 1 |
| 15 | 2200-0817 | Curette 8mm Right | 1 |
| 16 | 2200-0818 | Ring Curette 7mm | 1 |
| 17 | 2200-0819 | Sliding Hammer | 1 |
| 18 | 2200-0820 | Straight Implanter | 1 |
| 19 | 2200-0821 | Side Curette 8mm | 1 |
| 20 | 2200-0822 | Curette 8mm Left | 1 |
| 21 | 2200-0823 | Bone File | 1 |
| 22 | 2200-0824 | Aluminium Box | 1 |

Posterior Cervical Laminoplasty System Instrument Set

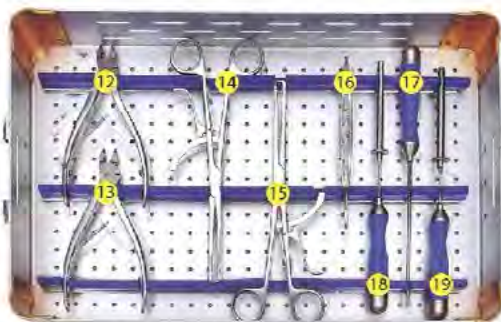
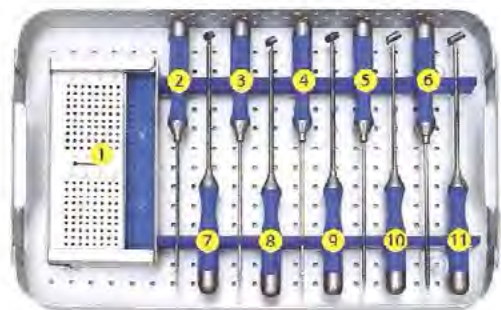

| | | | |
|----|-----------|-------------------------|---|
| 1 | 2200-0901 | Plate Box | 1 |
| 2 | 2200-0902 | Hand Drill Bit 1.5*4mm | 1 |
| 3 | 2200-0903 | Hand Drill Bit 1.5*6mm | 1 |
| 4 | 2200-0904 | Hand Drill Bit 1.5*8mm | 1 |
| 5 | 2200-0905 | Hand Drill Bit 1.5*10mm | 1 |
| 6 | 2200-0906 | Hand Drill Bit 1.5*12mm | 1 |
| 7 | 2200-0907 | Mold Trial 4mm | 1 |
| 8 | 2200-0908 | Mold Trial 6mm | 1 |
| 9 | 2200-0909 | Mold Trial 8mm | 1 |
| 10 | 2200-0910 | Mold Trial 10mm | 1 |
| 11 | 2200-0911 | Mold Trial 12mm | 1 |
| 12 | 2200-0912 | Bending Cutting Forcecp | 1 |
| 13 | 2200-0913 | Bending Cutting Forcecp | 1 |
| 14 | 2200-0914 | Plate Holding Forcecp | 1 |
| 15 | 2200-0915 | Plate Holding Forcecp | 1 |
| 16 | 2200-0916 | Plate Holding Clamp | 1 |
| 17 | 2200-0917 | AWL | 1 |
| 18 | 2200-0918 | Screwdriver | 1 |
| 19 | 2200-0919 | Screwdriver | 1 |
| 20 | 2200-0920 | Almunium Box | 1 |

Spinal Pedicle Screw System Instrument Set

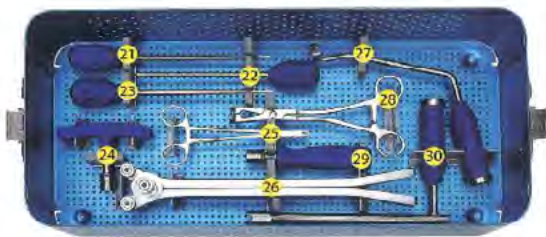
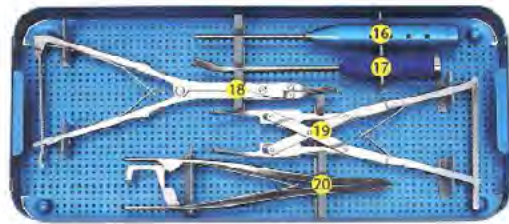
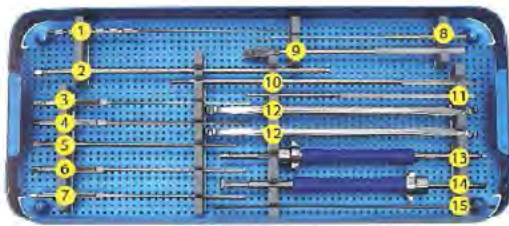

| | | | |
|----|-----------|---|---|
| 1 | 2200-0101 | Feeler for Screw Channel Straight | 1 |
| 2 | 2200-0102 | Hex Screwdriver for Srew Nut SW5.0 | 1 |
| 3 | 2200-0103 | Tap ϕ 4.0 | 1 |
| 4 | 2200-0104 | Tap ϕ 5.0 | 1 |
| 5 | 2200-0105 | Screwdriver Hex 3.5mm for Crosslink Nut | 1 |
| 6 | 2200-0106 | Tap ϕ 6.0 | 1 |
| 7 | 2200-0107 | Tap ϕ 7.0 | 1 |
| 8 | 2200-0108 | Feeler for Screw Channel Bent | 1 |
| 9 | 2200-0109 | Screw Cutter for Long Arm Screw | 1 |
| 10 | 2200-0110 | Screw Nut Holder Hex | 1 |
| 11 | 2200-0111 | Crosslink Nut Holder Hex | 1 |
| 12 | 2200-0112 | In-situ Bending Iron | 1 |
| 13 | 2200-0113 | Screwdriver for Polyaxial Screw | 1 |
| 14 | 2200-0114 | Screwdriver for Monoaxial Screw | 1 |
| 15 | 2200-0115 | Trail Rod | 1 |
| 16 | 2200-0116 | Insert Device for Fixation Pin | 1 |
| 17 | 2200-0117 | Rod Pusherial | 1 |
| 18 | 2200-0118 | Parallel Spreader | 1 |
| 19 | 2200-0119 | Parallel Compressor | 1 |
| 20 | 2200-0120 | Rod Twist | 1 |
| 21 | 2200-0121 | Pedicle Probe Straight | 1 |
| 22 | 2200-0122 | Pedicle Probe Bent | 1 |
| 23 | 2200-0123 | AWL | 1 |
| 24 | 2200-0124 | T handle Quick Coupling | 1 |
| 25 | 2200-0125 | Rod Holding Forcecp | 1 |
| 26 | 2200-0126 | Rod Bender | 1 |
| 27 | 2200-0127 | Counter Torque for Screw Cutter | 1 |
| 28 | 2200-0128 | Rod Pushing Forcecp | 1 |
| 29 | 2200-0129 | Straight Handle Quick Coupling | 1 |
| 30 | 2200-0130 | Counter Torque | 1 |
| 31 | 2200-0131 | Aluminium Box | 1 |

Humeral Intramedullally Nail Instrument Set

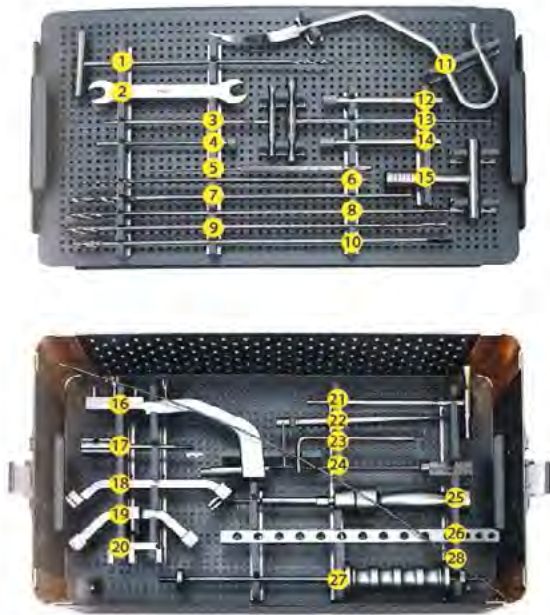

| | | | |
|----|-----------|--------------------------|---|
| 1 | 1200-0101 | Drill Bit 5.2mm | 1 |
| 2 | 1200-0102 | Open Wrench | 1 |
| 3 | 1200-0103 | Tap 3.5mm | 1 |
| 4 | 1200-0104 | Distal Positioning Frame | 1 |
| 5 | 1200-0105 | Depth Gauge 0-60mm | 1 |
| 6 | 1200-0106 | Drill Bit 2.9*250mm | 1 |
| 7 | 1200-0107 | Drill Bit 5.2*300mm | 1 |
| 8 | 1200-0108 | Reamer 8.5*340mm | 1 |
| 9 | 1200-0109 | Reamer 8.0*340mm | 1 |
| 10 | 1200-0110 | Reamer 7.5*340mm | 1 |
| 11 | 1200-0111 | AWL | 1 |
| 12 | 1200-0112 | Sleeve | 1 |
| 13 | 1200-0113 | Screwdriver SW2.5 | 1 |
| 14 | 1200-0114 | Sleeve | 1 |
| 15 | 1200-0115 | Quick Coupling T-Handle | 1 |
| 16 | 1200-0116 | Sighting Device Handle | 1 |
| 17 | 1200-0117 | Nail Connector | 1 |
| 18 | 1200-0118 | Distal Guider | 1 |
| 19 | 1200-0119 | Proximal Guider | 1 |
| 20 | 1200-0120 | Fixed Connector | 1 |
| 21 | 1200-0121 | Location Rod | 1 |
| 22 | 1200-0122 | Drill Sleeve | 1 |
| 23 | 1200-0123 | Hex Wrench | 1 |
| 24 | 1200-0124 | Gauge Cannula | 1 |
| 25 | 1200-0125 | Universal Joint | 1 |
| 26 | 1200-0126 | Guide Rod | 1 |
| 27 | 1200-0127 | Hammer | 1 |
| 28 | 1200-0128 | Guide Wire | 1 |
| 29 | 1200-0129 | Aluminium Box | 1 |

Tibia Intramedullally Nail Instrument Set

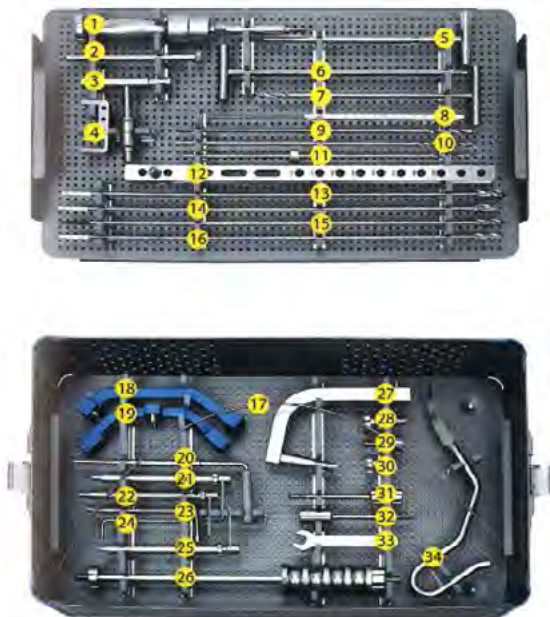

| | | | |
|----|-----------|--------------------------------------|---|
| 1 | 1200-0201 | Universal Joint | 1 |
| 2 | 1200-0202 | Drill Sleeve | 1 |
| 3 | 1200-0203 | Quick Coupling T-Handle | 1 |
| 4 | 1200-0204 | Fixed Connector | 1 |
| 5 | 1200-0205 | Location Rod | 1 |
| 6 | 1200-0206 | Screwdriver | 1 |
| 7 | 1200-0207 | T-handle Drill Bit 5.2mm | 1 |
| 8 | 1200-0208 | Depth Gauge 10-100mm | 1 |
| 9 | 1200-0209 | Drill Bit 5.2*300mm | 1 |
| 10 | 1200-0210 | Drill Bit 4.0*300mm | 1 |
| 11 | 1200-0211 | Drill Bit with Limitorator 4.0*300mm | 1 |
| 12 | 1200-0212 | Guide Rod | 1 |
| 13 | 1200-0213 | Reamer 8mm | 1 |
| 14 | 1200-0214 | Reamer 9mm | 1 |
| 15 | 1200-0215 | Reamer 10mm | 1 |
| 16 | 1200-0216 | Reamer 11mm | 1 |
| 17 | 1200-0217 | Guide Wire | 1 |
| 18 | 1200-0218 | Distal Guider | 1 |
| 19 | 1200-0219 | Proximal Guider | 1 |
| 20 | 1200-0220 | Location Forcep | 1 |
| 21 | 1200-0221 | Drill Sleeve | 1 |
| 22 | 1200-0222 | Drill Sleeve | 1 |
| 23 | 1200-0223 | Hex Wrench | 1 |
| 24 | 1200-0224 | Hex Wrench | 1 |
| 25 | 1200-0225 | Drill Sleeve | 1 |
| 26 | 1200-0226 | Hammer | 1 |
| 27 | 1200-0227 | Sighting Device Handle | 1 |
| 28 | 1200-0228 | Bolt | 1 |
| 29 | 1200-0229 | Bolt | 1 |
| 30 | 1200-0230 | Bolt | 1 |
| 31 | 1200-0231 | Nail Connector Solid | 1 |
| 32 | 1200-0232 | Nail Connector Cannulated | 1 |
| 33 | 1200-0233 | Open Wrench | 1 |
| 34 | 1200-0234 | AWL | 1 |
| 35 | 1200-0235 | Aluminium Box | 1 |

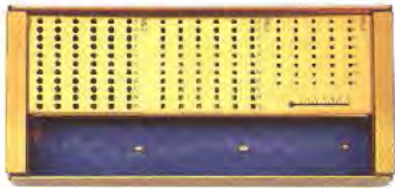

1.5/2.0/2.7 Screw Box 5100-0101



3.5/4.0 Screw Box 5100-0201



4.5/6.5 Screw Box 5100-0301



3.5/4.0 Screw Rack 5100-0401



4.5/6.5 Screw Rack 5100-0501



K-wire Rack 5100-1201



Small Fragment Locking
Screw Rack 5100-0601



Large Fragment Locking
Screw Rack 5100-0701

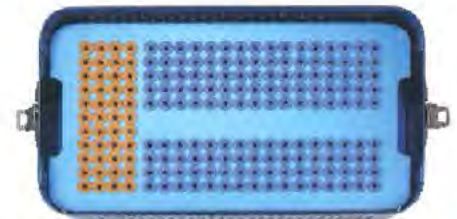

Spinal Pedicle Screw Box
5100-0801

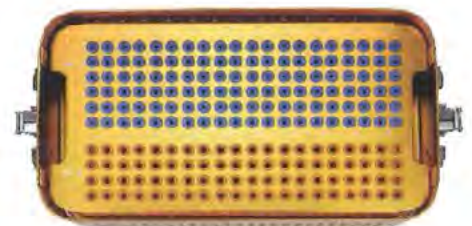

Posterior Cervical Screw Box
5100-0901

Small Fragment Instrument Set

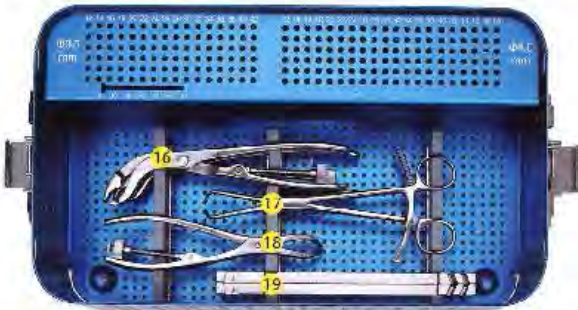
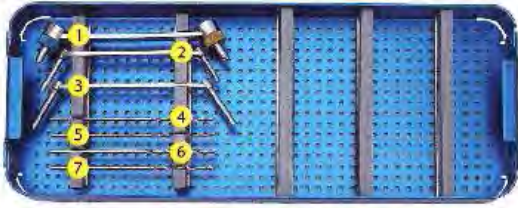

| | | | |
|----|-----------|--|---|
| 1 | 4200-0101 | Neutral and Load Drill Guide $\Phi 2.5$ | 1 |
| 2 | 4200-0102 | Drill & Tap Guider ($\Phi 2.5/\Phi 3.5$) | 1 |
| 3 | 4200-0103 | Drill & Tap Guider ($\Phi 3.5/\Phi 4.0$) | 1 |
| 4 | 4200-0104 | Drill Bit ($\Phi 2.5 \times 115\text{mm}$) | 1 |
| 5 | 4200-0105 | Drill Bit ($\Phi 2.5 \times 115\text{mm}$) | 1 |
| 6 | 4200-0106 | Drill Bit ($\Phi 3.2 \times 115\text{mm}$) | 1 |
| 7 | 4200-0107 | Drill Bit ($\Phi 3.2 \times 115\text{mm}$) | 1 |
| 8 | 4200-0108 | Periosteal Elevator 6mm | 1 |
| 9 | 4200-0109 | Tap Cancellous 4.0mm | 1 |
| 10 | 4200-0110 | Depth Gauge (0-60mm) | 1 |
| 11 | 4200-0111 | Countersink | 1 |
| | 4200-0112 | Extraction Screw Hexagonal 2.5mm Conical | 1 |
| 12 | 4200-0113 | Periosteal Elevator 12mm | 1 |
| 13 | 4200-0114 | Hollow Reamer $\Phi 6.0$ | 1 |
| 14 | 4200-0115 | Tap Cortex 3.5mm | 1 |
| 15 | 4200-0116 | Silicon Handle Scredriver Hexagonal 2.5mm | 1 |
| 16 | 4200-0117 | Self-centering Bone Holding Forcep (190mm) | 2 |
| 17 | 4200-0118 | Sharp Reduction Forcep (190mm) | 1 |
| 18 | 4200-0119 | Oblique Reduction Forcep (170mm) | 1 |
| 19 | 4200-0120 | Bending Iron | 1 |
| 20 | 4200-0121 | Aluminium Box | 1 |

Large Fragment Instrument Set

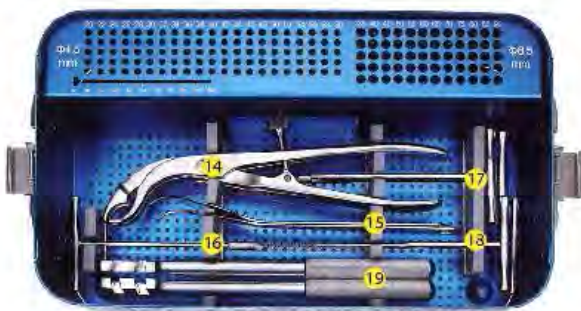
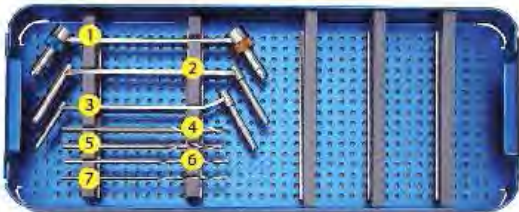

| | | | |
|----|-----------|--|---|
| 1 | 4200-0201 | Neutral and Load Drill Guide $\Phi 3.2$ | 1 |
| 2 | 4200-0202 | Drill & Tap Guider ($\Phi 4.5/\Phi 6.5$) | 1 |
| 3 | 4200-0203 | Drill & Tap Guider ($\Phi 3.2/\Phi 4.5$) | 1 |
| 4 | 4200-0204 | Drill Bit ($\Phi 4.5 \times 115\text{mm}$) | 1 |
| 5 | 4200-0205 | Drill Bit ($\Phi 4.5 \times 115\text{mm}$) | 1 |
| 6 | 4200-0206 | Drill Bit ($\Phi 3.2 \times 115\text{mm}$) | 1 |
| 7 | 4200-0207 | Drill Bit ($\Phi 3.2 \times 115\text{mm}$) | 1 |
| 8 | 4200-0208 | Depth Gauge (0-90mm) | 1 |
| 9 | 4200-0209 | Periosteal Elevator 15mm | 1 |
| 10 | 4200-0210 | Oblique Reduction Forcep (230mm) | 1 |
| 11 | 4200-0211 | Periosteal Elevator 8mm | 1 |
| 12 | 4200-0212 | Sharp Reduction Forcep (200mm) | 1 |
| 13 | 4200-0213 | Silicon Handle Screwdriver Hexagonal 3.5mm | 1 |
| 14 | 4200-0214 | Self-centering Bone Holding Forcep (270mm) | 2 |
| 15 | 4200-0215 | Retractor Width 40mm/18mm | 1 |
| 16 | 4200-0216 | Countersink $\Phi 8.0$ | 1 |
| 17 | 4200-0217 | Hollow Reamer $\Phi 8.0$ | 1 |
| | 4200-0218 | Extraction Screw Hexagonal 3.5mm Conical | 1 |
| 18 | 4200-0219 | Tap Cortex 4.5mm | 1 |
| | 4200-0220 | Tap Cancellous 6.5mm | 1 |
| 19 | 4200-0221 | Bending Iron | 1 |
| 20 | 4200-0222 | Aluminium Box | 1 |

Femoral Intramedullary Nail Instrument Set

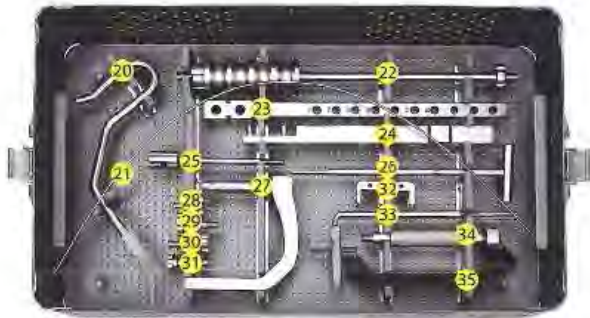
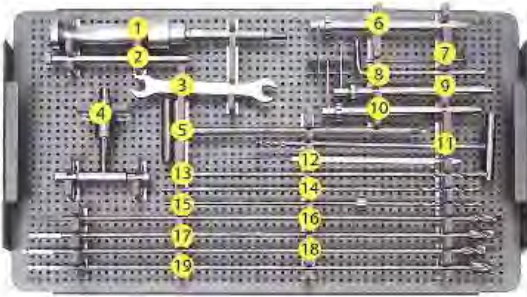

| | | | |
|----|-----------|---|---|
| 1 | 1200-0301 | Universal Joint | 1 |
| 2 | 1200-0302 | Drill Sleeve | 1 |
| 3 | 1200-0303 | Open Wrench | 1 |
| 4 | 1200-0304 | Quick Coupling T-Handle | 1 |
| 5 | 1200-0305 | Screwdriver | 1 |
| 6 | 1200-0306 | Drill Sleeve | 1 |
| 7 | 1200-0307 | Hex Wrench | 1 |
| 8 | 1200-0308 | Hex Wrench | 1 |
| 9 | 1200-0309 | Drill Sleeve | 1 |
| 10 | 1200-0310 | Drill Sleeve | 1 |
| 11 | 1200-0311 | T-handle Drill Bit | 1 |
| 12 | 1200-0312 | Depth Gague 10-100mm | 1 |
| 13 | 1200-0313 | Drill Bit 5.2*300mm | 1 |
| 14 | 1200-0314 | Drill Bit $\phi 4.0*300$ | 1 |
| 15 | 1200-0315 | Drill Bit with Limitator $\phi 4.0*300$ | 1 |
| 16 | 1200-0316 | Reamer 10mm | 1 |
| 17 | 1200-0317 | Reamer 11mm | 1 |
| 18 | 1200-0318 | Reamer 12mm | 1 |
| 19 | 1200-0319 | Reamer 13mm | 1 |
| 20 | 1200-0320 | AWL | 1 |
| 21 | 1200-0321 | Guide Wire | 1 |
| 22 | 1200-0322 | Hammer | 1 |
| 23 | 1200-0323 | Guide Rod | 1 |
| 24 | 1200-0324 | Connctor Rod | 1 |
| 25 | 1200-0325 | Nail Connector | 1 |
| 26 | 1200-0326 | Location Rod | 1 |
| 27 | 1200-0327 | Sighting Device Handle | 1 |
| 28 | 1200-0328 | Bolt | 1 |
| 29 | 1200-0329 | Bolt | 1 |
| 30 | 1200-0330 | Bolt | 1 |
| 31 | 1200-0331 | Bolt | 1 |
| 32 | 1200-0332 | Fixed Connector | 1 |
| 33 | 1200-0333 | Location Forcep | 1 |
| 34 | 1200-0334 | Connector | 1 |
| 35 | 1200-0335 | Distal Guider | 1 |
| 36 | 1200-0336 | Aluminium Box | 1 |

Reversed Femoral & Gama Intramedullary Nail Instrument Set

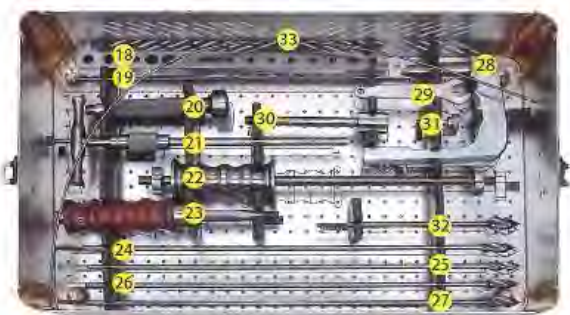
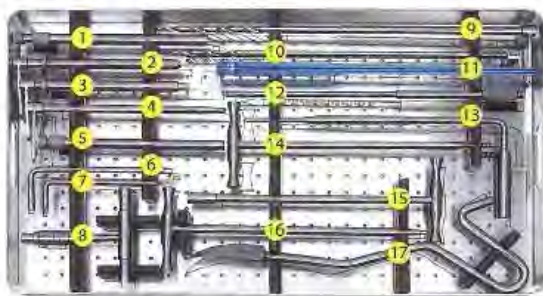

| | | | |
|----|-----------|-------------------------------------|---|
| 1 | 1200-0401 | Guide Drill + Sleeve | 1 |
| 2 | 1200-0402 | Guide Drill + Sleeve | 1 |
| 3 | 1200-0403 | Guide Drill + Sleeve | 1 |
| 4 | 1200-0404 | Guide Drill + Sleeve | 1 |
| 5 | 1200-0405 | Forcing Cone | 1 |
| 6 | 1200-0406 | L-wrench Large | 1 |
| 7 | 1200-0407 | L-wrench Small | 1 |
| 8 | 1200-0408 | T-handle Quick Coupling | 1 |
| 9 | 1200-0409 | Sleeve + Drill Bit | 1 |
| 10 | 1200-0410 | Drill Bit with Limitator $\phi 3.5$ | 1 |
| 11 | 1200-0411 | Wire Depth Gague | 1 |
| 12 | 1200-0412 | Depth Gague | 1 |
| 13 | 1200-0413 | L-shaped Location Forcep | 1 |
| 14 | 1200-0414 | Tap | 1 |
| 15 | 1200-0415 | Wrench | 1 |
| 16 | 1200-0416 | Location Forcep | 1 |
| 17 | 1200-0417 | AWL | 1 |
| 18 | 1200-0418 | Guide Rod | 1 |
| 19 | 1200-0419 | K-wire | 3 |
| 20 | 1200-0420 | Straight Handle | 1 |
| 21 | 1200-0421 | T-location Forcep | 1 |
| 22 | 1200-0422 | Impactor and Extractor | 1 |
| 23 | 1200-0423 | Universal Joint | 1 |
| 24 | 1200-0424 | Reamer $\phi 10$ | 1 |
| 25 | 1200-0425 | Reamer $\phi 11$ | 1 |
| 26 | 1200-0426 | Reamer $\phi 12$ | 1 |
| 27 | 1200-0427 | Reamer $\phi 13$ | 1 |
| 28 | 1200-0428 | Guider Handle | 1 |
| 29 | 1200-0429 | Wrench | 1 |
| 30 | 1200-0430 | Connctor Rod | 1 |
| 31 | 1200-0431 | Screw Bolt | 1 |
| 32 | 1200-0432 | Reamer $\phi 9$ | 1 |
| 33 | 1200-0433 | Guider Wire | 1 |

Femoral Reconstruction Intramedullary Nail Instrument Set

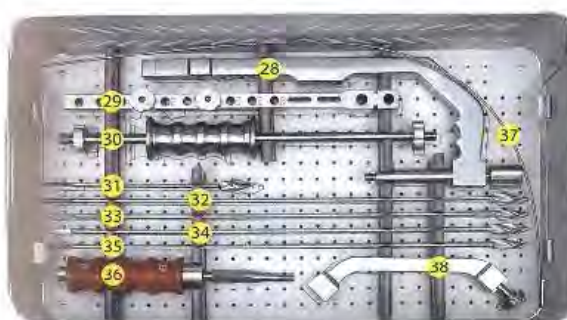
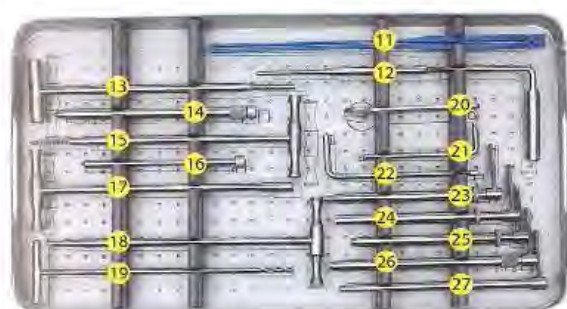
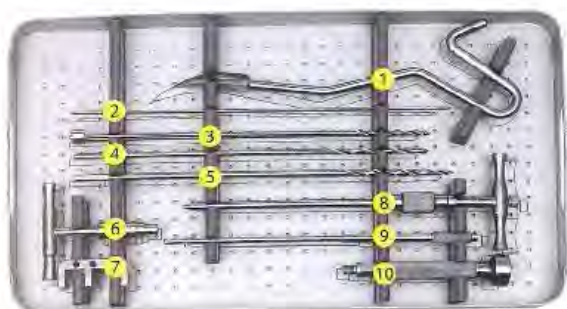

| | | | |
|----|-----------|-------------------------------------|---|
| 1 | 1200-0501 | AWL | 1 |
| 2 | 1200-0502 | K-wire | 3 |
| 3 | 1200-0503 | Drill Bit with Limitator ϕ 3.5 | 1 |
| 4 | 1200-0504 | Drill Bit | 1 |
| 5 | 1200-0505 | Drill Bit | 1 |
| 6 | 1200-0506 | T-handle Quick Coupling | 1 |
| 7 | 1200-0507 | Lock | 1 |
| 8 | 1200-0508 | T-location Forcep | 1 |
| 9 | 1200-0509 | Depth Gague | 1 |
| 10 | 1200-0510 | Straight Handle | 1 |
| 11 | 1200-0511 | Wire Depth Gague | 1 |
| 12 | 1200-0512 | L-shaped Location Forcep | 1 |
| 13 | 1200-0513 | Location Forcep | 1 |
| 14 | 1200-0514 | Forcing Cone | 1 |
| 15 | 1200-0515 | Tap | 1 |
| 16 | 1200-0516 | Forcing Cone | 1 |
| 17 | 1200-0517 | Wrench | 1 |
| 18 | 1200-0518 | Hex Srewdriver | 1 |
| 19 | 1200-0519 | L-shaped Location Forcep | 1 |
| 20 | 1200-0520 | Wrench | 1 |
| 21 | 1200-0521 | L-wrench Large | 1 |
| 22 | 1200-0522 | L-wrench Small | 1 |
| 23 | 1200-0523 | Guide Drill + Sleeve | 1 |
| 24 | 1200-0524 | Guide Drill + Sleeve | 1 |
| 25 | 1200-0525 | Guide Drill + Sleeve | 1 |
| 26 | 1200-0526 | Guide Drill + Sleeve | 1 |
| 27 | 1200-0527 | Guide Drill + Sleeve | 1 |
| 28 | 1200-0528 | Guide Handle | 1 |
| 29 | 1200-0529 | Guide Rod | 1 |
| 30 | 1200-0530 | Impactor and Extractor | 1 |
| 31 | 1200-0531 | Reamer ϕ 10.4 | 1 |
| 32 | 1200-0532 | Reamer ϕ 11 | 1 |
| 33 | 1200-0533 | Reamer ϕ 12 | 1 |
| 34 | 1200-0534 | Reamer ϕ 12.5 | 1 |
| 35 | 1200-0535 | Reamer ϕ 13 | 1 |
| 36 | 1200-0536 | Universal Joint | 1 |
| 37 | 1200-0537 | Guider Wire | 1 |
| 38 | 1200-0538 | Guider Bar | 1 |
| 39 | 1200-0539 | Aluminium Box | 1 |

Elastic Nail Instrument Set

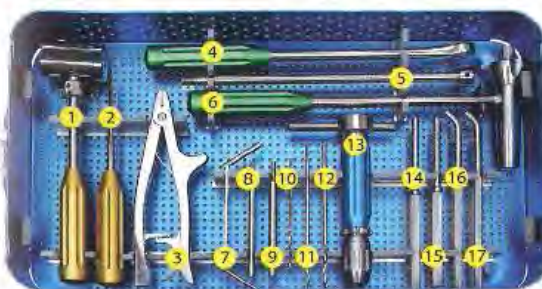
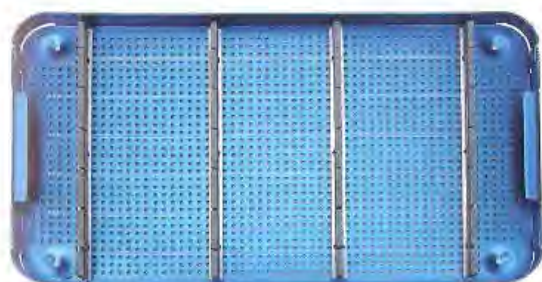

| | | | |
|----|-----------|-------------------------------|---|
| 1 | 1200-0601 | Hammer | 1 |
| 2 | 1200-0602 | AWL | 1 |
| 3 | 1200-0603 | Locking Pliers | 1 |
| 4 | 1200-0604 | Cutter | 1 |
| 5 | 1200-0605 | Hammer Guider | 1 |
| 6 | 1200-0606 | Cutter | 1 |
| 7 | 1200-0607 | Double Drill Sleeve 3.2/4.5mm | 1 |
| 8 | 1200-0608 | End Cup Inserter Small | 1 |
| 9 | 1200-0609 | End Cup Inserter Large | 1 |
| 10 | 1200-0610 | Drill Bit ϕ 2.7*115mm | 1 |
| 11 | 1200-0611 | Drill Bit ϕ 3.2*150mm | 1 |
| 12 | 1200-0612 | Drill Bit ϕ 4.5*150mm | 1 |
| 13 | 1200-0613 | Elastic Nail Inserter | 1 |
| 14 | 1200-0614 | Standard Tamp | 1 |
| 15 | 1200-0615 | Beveled Tamp | 1 |
| 16 | 1200-0616 | Bender | 1 |
| 17 | 1200-0617 | Bender | 1 |
| 18 | 1200-0618 | Aluminium Box | 1 |

New Femoral Reconstruction Intramedullary Nail Instrument Set

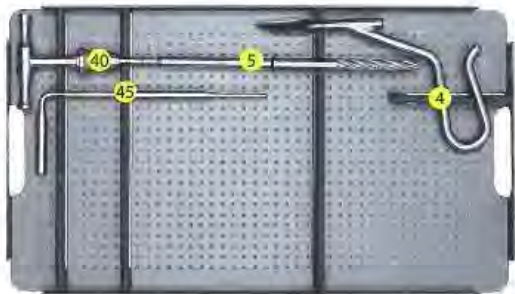
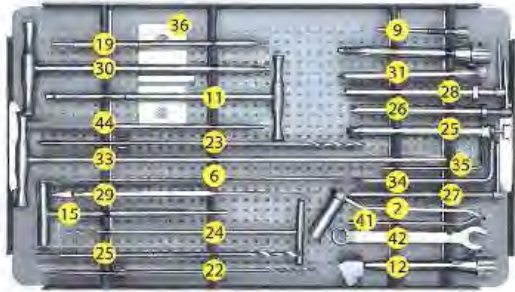

| | | | |
|----|-----------|---|---|
| 1 | 1200-0801 | Locking Pipe | 1 |
| 2 | 1200-0802 | Soft Tissue Separating Device Long | 1 |
| 3 | 1200-0803 | Locking Drills ϕ 4.3 | 1 |
| 4 | 1200-0804 | Locking Nail Bone Drill ϕ 4.3 | 1 |
| 5 | 1200-0805 | Limit Device ϕ 4.3 | 1 |
| 6 | 1200-0806 | Locking Hole Depth Gauge | 1 |
| 7 | 1200-0807 | Locking Spanner SW4.0 | 1 |
| 8 | 1200-0808 | Femur Neck Nail/Tail Spanner SW5/M3.5 | 1 |
| 9 | 1200-0809 | Femur Neck Nail Drill ϕ 6.4 | 1 |
| 10 | 1200-0810 | Limit Device ϕ 6.4 | 1 |
| 11 | 1200-0811 | Femur Neck Nail Drill ϕ 6.4 | 1 |
| 12 | 1200-0812 | Fumer Neck Guide Depth Gauge ϕ 2.5*320 | 1 |
| 13 | 1200-0813 | Femur Neck Screw Guide Pin ϕ 2.5*320 | 1 |
| 14 | 1200-0814 | Femur Nech Guide Pin ϕ 2.5*320 | 1 |
| 15 | 1200-0815 | Femur Neck Guide Drill Set ϕ 2.5 | 1 |
| 16 | 1200-0816 | Proximal Enlargement | 1 |
| 17 | 1200-0817 | Proximal Hard Enlarge Limit Device | 1 |
| 18 | 1200-0818 | Limit Spanner SW3 | 1 |
| 19 | 1200-0819 | Protection Skin Board | 1 |
| 20 | 1200-0820 | Guide Pin Device | 1 |
| 21 | 1200-0821 | AWL | 1 |
| 22 | 1200-0822 | Handle | 1 |
| 23 | 1200-0823 | Reduction Rod (Gudie Pin) | 1 |
| 24 | 1200-0824 | Soft Knife Rod ϕ 2.5/ ϕ 8 | 1 |
| 25 | 1200-0825 | Soft Knife Head ϕ 8.5 | 1 |
| 26 | 1200-0826 | Soft Knife Head ϕ 9 | 1 |
| 27 | 1200-0827 | Soft Knife Head ϕ 9.5 | 1 |
| 28 | 1200-0828 | Soft Knife Head ϕ 10 | 1 |
| 29 | 1200-0829 | Soft Knife Head ϕ 10.5 | 1 |
| 30 | 1200-0830 | Soft Knife Head ϕ 11 | 1 |
| 31 | 1200-0831 | Soft Knife Head ϕ 11.5 | 1 |
| 32 | 1200-0832 | Soft Knife Head ϕ 12 | 1 |
| 33 | 1200-0833 | Soft Knife Head ϕ 12.5 | 1 |
| 34 | 1200-0834 | Soft Knife Head ϕ 13 | 1 |
| 35 | 1200-0835 | Ball Head Guide Pin ϕ 2.5/ ϕ 4 | 1 |
| 36 | 1200-0836 | Proximal Guide Rod | 1 |
| 37 | 1200-0837 | Connecting Screw Spanner SW6.5 | 1 |
| 38 | 1200-0838 | Distal Guide Rod | 1 |
| 39 | 1200-0839 | Distal Positioning Frame | 1 |
| 40 | 1200-0840 | Connecting Guide Pin Locking Wheel | 1 |
| 41 | 1200-0841 | Positioning Card | 1 |
| 42 | 1200-0842 | Positioning Rod | 1 |
| 43 | 1200-0843 | Pull Device | 1 |
| 44 | 1200-0844 | Handle | 1 |
| 45 | 1200-0845 | Connecting Screw | 1 |
| 46 | 1200-0846 | Connecting Handle Wheel | 1 |
| 47 | 1200-0847 | Locking Wheel Spanner SW5 | 1 |
| 48 | 1200-0848 | Positioning Pipe | 1 |
| 49 | 1200-0849 | Soft Tissue Separating Device Short | 1 |
| 50 | 1200-0850 | Positioning Drill Set ϕ 5.2 | 1 |
| 51 | 1200-0851 | Positioning Bone Drill ϕ 5.2 | 1 |
| 52 | 1200-0852 | Positioning Flat Drill ϕ 5.2 | 1 |
| 53 | 1200-0853 | Connecting Screw Universal Spanner SW6.5 | 1 |
| 54 | 1200-0854 | Main Nail Pull Connecting Rod | 1 |
| 55 | 1200-0855 | Aluminium Box | 1 |

ANT Tibia Intramedullary Nail Instrument Set

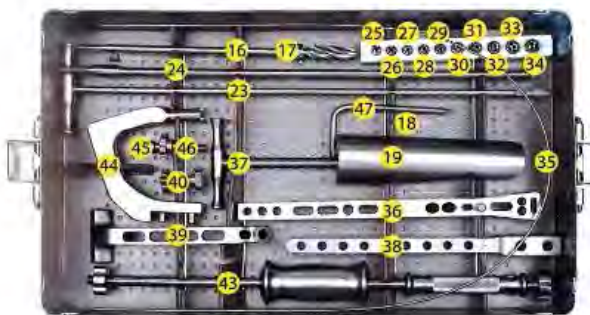
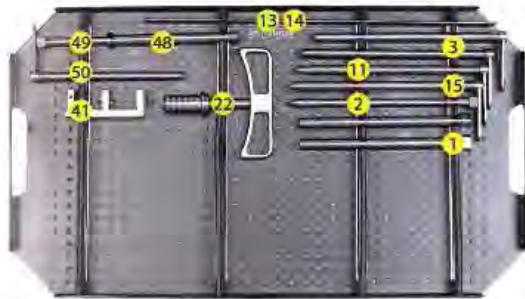
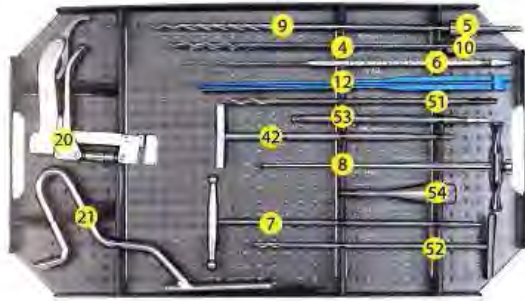

| | | | |
|----|-----------|--|---|
| 1 | 1200-0901 | Proximal Knife Rod T Handle | 1 |
| 2 | 1200-0902 | Proximal Knife Rod $\phi 12/\phi 3.2$ | 1 |
| 3 | 1200-0903 | Right Angle Locking Rod | 1 |
| 4 | 1200-0904 | Cannulated AWL | 1 |
| 5 | 1200-0905 | Nail Driver Extractor Connector | 1 |
| 6 | 1200-0906 | Wrench | 1 |
| 7 | 1200-0907 | Connector Wrench | 1 |
| 8 | 1200-0908 | Protection Sleeve $\phi 12$ | 1 |
| 9 | 1200-0909 | Positioning Rod Sleeve $\phi 3.2$ | 1 |
| 10 | 1200-0910 | Frame Rods Locking Screw Driver SW5 | 1 |
| 11 | 1200-0911 | Drill Stopper Screw Driver SW3 | 1 |
| 12 | 1200-0912 | Cancellous Screw Drill Sleeve Set $\phi 3.2, 8, 6, 11$ | 1 |
| 13 | 1200-0913 | Drill Sleeve Set $\phi 4.0$ | 1 |
| 14 | 1200-0914 | Trocar | 1 |
| 15 | 1200-0915 | Nail Extract Connecting Rod | 1 |
| 16 | 1200-0916 | Compression Bolt | 1 |
| 17 | 1200-0917 | Bone Drill $\phi 3.2$ | 1 |
| 18 | 1200-0918 | Drill Stopper | 1 |
| 19 | 1200-0919 | Bone Drill $\phi 5.2$ | 1 |
| 20 | 1200-0920 | Positioning Rod Flat Head Drill $\phi 5.2$ | 1 |
| 21 | 1200-0921 | Position Rod | 1 |
| 22 | 1200-0922 | Depth Gauge | 1 |
| 23 | 1200-0923 | Threaded Guide Pin | 1 |
| 24 | 1200-0924 | Guide Pin Guider | 1 |
| 25 | 1200-0925 | Bone Drill $\phi 4.0$ | 1 |
| 26 | 1200-0926 | Drill Stopper $\phi 4.0$ | 1 |
| 27 | 1200-0927 | Hex Screw Holder SW3.5 | 1 |
| 28 | 1200-0928 | Connecting Rod Universal Driver SW6.5 | 1 |
| 29 | 1200-0929 | Locking Screw Driver SW3.5 | 1 |
| 30 | 1200-0930 | Protection Plate | 1 |
| 31 | 1200-0931 | Guide Pin | 1 |
| 32 | 1200-0932 | Sliding Hammer | 1 |
| 33 | 1200-0933 | Frame Guide Rod | 1 |
| 34 | 1200-0934 | Guide Pin Holder | 1 |
| 35 | 1200-0935 | Reamer Shaft | 1 |
| 36 | 1200-0936 | Sliding Hammer Guide Rod | 1 |
| 37 | 1200-0937 | Developing Calculator | 1 |
| 38 | 1200-0938 | Connecting Bolt | 1 |
| 39 | 1200-0939 | Insertion Handle | 1 |
| 40 | 1200-0940 | U-shaped Locking Block | 1 |
| 41 | 1200-0941 | Connecting Rod Screwdriver SW6.5 | 1 |
| 42 | 1200-0942 | Distal Target Device | 1 |
| 43 | 1200-0943 | Flexible Reamer Bit $\phi 7.5-12$ | 1 |
| 44 | 1200-0944 | Cannulated Chisel $\phi 12/3.2$ | 1 |
| 45 | 1200-0945 | Proximal Target Device | 1 |
| 46 | 1200-0946 | Proximal Cancellous Target Device | 1 |
| 47 | 1200-0947 | Proximal Cancellous Target Device Locking Screw | 1 |
| 48 | 1200-0948 | Aluminium Box | 1 |

Small Fragment Instrument Set

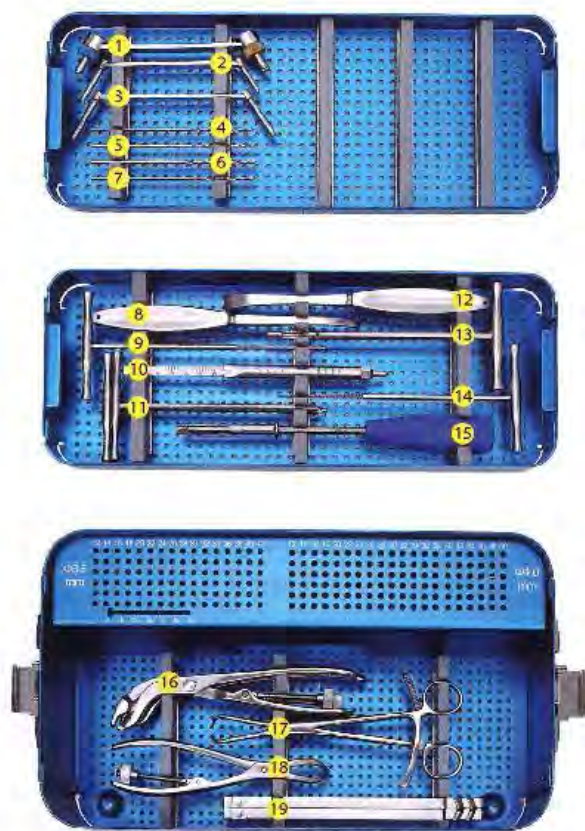

| | | | |
|----|-----------|--|---|
| 1 | 4200-0101 | Neutral and Load Drill Guide $\Phi 2.5$ | 1 |
| 2 | 4200-0102 | Drill & Tap Guider ($\Phi 2.5/\Phi 3.5$) | 1 |
| 3 | 4200-0103 | Drill & Tap Guider ($\Phi 3.5/\Phi 4.0$) | 1 |
| 4 | 4200-0104 | Drill Bit ($\Phi 2.5 \times 115\text{mm}$) | 1 |
| 5 | 4200-0105 | Drill Bit ($\Phi 2.5 \times 115\text{mm}$) | 1 |
| 6 | 4200-0106 | Drill Bit ($\Phi 3.2 \times 115\text{mm}$) | 1 |
| 7 | 4200-0107 | Drill Bit ($\Phi 3.2 \times 115\text{mm}$) | 1 |
| 8 | 4200-0108 | Periosteal Elevator 6mm | 1 |
| 9 | 4200-0109 | Tap Cancellous 4.0mm | 1 |
| 10 | 4200-0110 | Depth Gauge (0-60mm) | 1 |
| 11 | 4200-0111 | Countersink | 1 |
| | 4200-0112 | Extraction Screw Hexagonal 2.5mm Conical | 1 |
| 12 | 4200-0113 | Periosteal Elevator 12mm | 1 |
| 13 | 4200-0114 | Hollow Reamer $\Phi 6.0$ | 1 |
| 14 | 4200-0115 | Tap Cortex 3.5mm | 1 |
| 15 | 4200-0116 | Silicon Handle Screddriver Hexagonal 2.5mm | 1 |
| 16 | 4200-0117 | Self-centering Bone Holding Forcep (190mm) | 2 |
| 17 | 4200-0118 | Sharp Reduction Forcep (190mm) | 1 |
| 18 | 4200-0119 | Oblique Reduction Forcep (170mm) | 1 |
| 19 | 4200-0120 | Bending Iron | 1 |
| 20 | 4200-0121 | Aluminium Box | 1 |

Large Fragment Instrument Set

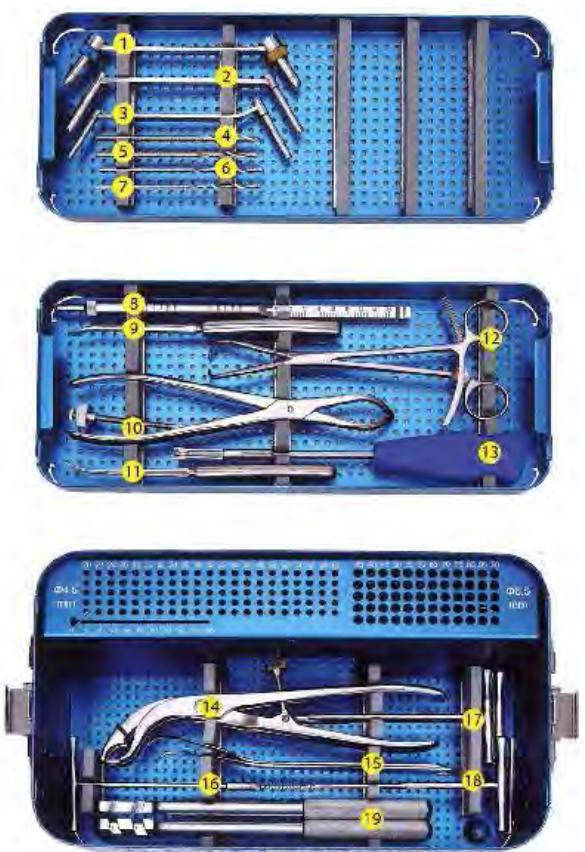

| | | | |
|----|-----------|--|---|
| 1 | 4200-0201 | Neutral and Load Drill Guide $\Phi 3.2$ | 1 |
| 2 | 4200-0202 | Drill & Tap Guider ($\Phi 4.5/\Phi 6.5$) | 1 |
| 3 | 4200-0203 | Drill & Tap Guider ($\Phi 3.2/\Phi 4.5$) | 1 |
| 4 | 4200-0204 | Drill Bit ($\Phi 4.5 \times 115\text{mm}$) | 1 |
| 5 | 4200-0205 | Drill Bit ($\Phi 4.5 \times 115\text{mm}$) | 1 |
| 6 | 4200-0206 | Drill Bit ($\Phi 3.2 \times 115\text{mm}$) | 1 |
| 7 | 4200-0207 | Drill Bit ($\Phi 3.2 \times 115\text{mm}$) | 1 |
| 8 | 4200-0208 | Depth Gauge (0-90mm) | 1 |
| 9 | 4200-0209 | Periosteal Elevator 15mm | 1 |
| 10 | 4200-0210 | Oblique Reduction Forcep (230mm) | 1 |
| 11 | 4200-0211 | Periosteal Elevator 8mm | 1 |
| 12 | 4200-0212 | Sharp Reduction Forcep (200mm) | 1 |
| 13 | 4200-0213 | Silicon Handle Screwdriver Hexagonal 3.5mm | 1 |
| 14 | 4200-0214 | Self-centering Bone Holding Forcep (270mm) | 2 |
| 15 | 4200-0215 | Retractor Width 40mm/18mm | 1 |
| 16 | 4200-0216 | Countersink $\Phi 8.0$ | 1 |
| 17 | 4200-0217 | Hollow Reamer $\Phi 8.0$ | 1 |
| | 4200-0218 | Extraction Screw Hexagonal 3.5mm Conical | 1 |
| 18 | 4200-0219 | Tap Cortex 4.5mm | 1 |
| | 4200-0220 | Tap Cancellous 6.5mm | 1 |
| 19 | 4200-0221 | Bending Iron | 1 |
| 20 | 4200-0222 | Aluminium Box | 1 |

Micro Plate Instrument Set

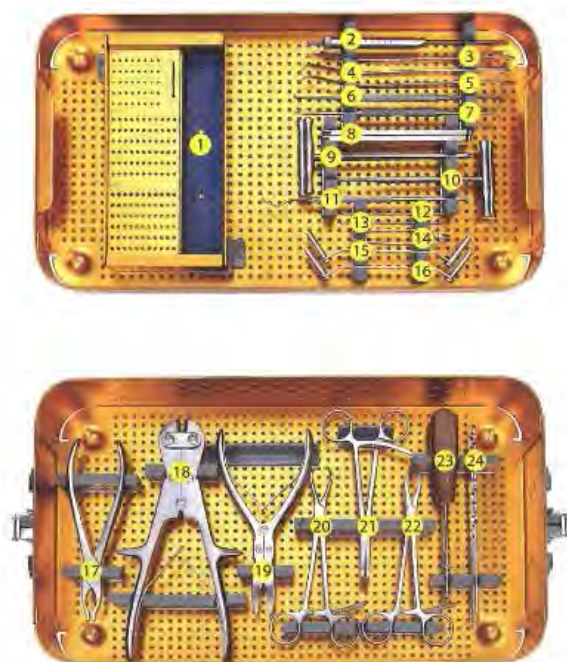

| | | | |
|----|-----------|-------------------------------|---|
| 1 | 4200-0301 | Screw Box(1.5/2.0/2.7mm) | 1 |
| 2 | 4200-0302 | Depth Gague(0-40mm) | 1 |
| 3 | 4200-0303 | Bone Elevator Large | 1 |
| 4 | 4200-0304 | Bone Elevator Medium | 1 |
| 5 | 4200-0305 | Bone Elevator Small | 1 |
| 6 | 4200-0306 | Dissector 5mm | 1 |
| 7 | 4200-0307 | Dissector 3mm | 1 |
| 8 | 4200-0308 | Bending Iron | 1 |
| 9 | 4200-0309 | Countersink HA2.7 | 1 |
| | 4200-0310 | Countersink HA2.0 | 1 |
| 10 | 4200-0311 | Tap HA2.0 | 1 |
| | 4200-0312 | Tap HA2.7 | 1 |
| 11 | 4200-0313 | Sharp Hook | 1 |
| 12 | 4200-0314 | Drill bit (Φ1.5) | 2 |
| 13 | 4200-0315 | Drill bit (Φ2.0) | 2 |
| 14 | 4200-0316 | Screw Forcep | 1 |
| 15 | 4200-0317 | Guider(Φ2.0/Φ2.7) | 1 |
| 16 | 4200-0318 | Guider(Φ1.5/Φ2.0) | 1 |
| 17 | 4200-0319 | Plate-bended Forcep | 1 |
| 18 | 4200-0320 | Wire Cutter | 1 |
| 19 | 4200-0321 | Bone Ribbing Rongeur | 1 |
| 20 | 4200-0322 | Pointed-tip Reduction Forceps | 1 |
| 21 | 4200-0323 | Bent-tip Reduction Forceps | 1 |
| 22 | 4200-0324 | Plate-hold Forceps | 1 |
| 23 | 4200-0325 | Hex Screwdriver SW2.0 | 1 |
| 24 | 4200-0326 | Skin Retractor | 1 |
| 25 | 4200-0327 | Aluminum Box | 1 |

Mini Fragment Instrument Set



| | | | |
|----|-----------|--|---|
| 1 | 4200-0401 | Tap HA1.5 | 3 |
| 2 | 4200-0402 | Guider 1.1/1.5 | 1 |
| 3 | 4200-0403 | Drill Bit 1.1*80mm | 1 |
| 4 | 4200-0404 | Tap HA2.0 | 3 |
| 5 | 4200-0405 | Guider 1.5/2.0 | 1 |
| 6 | 4200-0406 | Drill Bit 1.5*80mm | 1 |
| 7 | 4200-0407 | Tap HA2.7 | 3 |
| 8 | 4200-0408 | Guider 2.0/2.7 | 1 |
| 9 | 4200-0409 | Drill Bit 2.0*80mm | 1 |
| 10 | 4200-0410 | Plate-hold Forceps | 1 |
| 11 | 4200-0411 | Plate-bended Forcep | 1 |
| 12 | 4200-0412 | Retractors 1*3 | 1 |
| 13 | 4200-0413 | Dissector 5mm | 1 |
| 14 | 4200-0414 | Dissector 3mm | 1 |
| | 4200-0415 | Sharp Hook | 1 |
| 15 | 4200-0416 | Bending Iron | 1 |
| 16 | 4200-0417 | Wire Cutter | 1 |
| 17 | 4200-0418 | T-handle Quick Coupling | 1 |
| 18 | 4200-0419 | Screw Forcep | 1 |
| | 4200-0420 | Pointed-tip Reduction Forcep | 1 |
| 19 | 4200-0421 | Bent-tip Reduction Forcep | 1 |
| | 4200-0422 | Shape-made Forcep | 1 |
| 20 | 4200-0423 | Quick Coupling Screwdriver Hex (SW2.0) | 1 |
| | 4200-0424 | Countersink | 1 |
| 21 | 4200-0425 | Straight Handle Quick Coupling | 1 |
| 22 | 4200-0426 | Depth Gague 0-40mm | 1 |
| 23 | 4200-0427 | Skin Retractor | 1 |
| 24 | 4200-0431 | Aluminum Box | 1 |

Rib Plate Instrument Set



| | | | |
|---|-----------|-------------------------------|---|
| 1 | 4200-0901 | Reduction Forcep Double Large | 1 |
| 2 | 4200-0902 | Reduction Forcep Curved | 1 |
| 3 | 4200-0903 | Reduction Forcep Double Small | 1 |
| 4 | 4200-0904 | Reduction Forcep Single | 1 |
| 5 | 4200-0905 | Plate Insert Forcep | 1 |
| 6 | 4200-0906 | Rib Plate Cutter | 1 |
| 7 | 4200-0907 | Periosteal Elevator 9mm | 1 |
| 8 | 4200-0908 | Periosteal Elevator 12mm | 1 |
| 9 | 4200-0909 | Aluminium Box | 1 |

1,5/2,0 mm Maxillofacial Plate Instrument Set



1,5/2,0mm Maxillofacial Plate
Cutter & Bender L
3128-0123

1,5/2,0mm Maxillofacial Plate
Cutter & Bender R
3128-0122

| | | | |
|----|-----------|-----------------------------|---|
| 1 | 3128-0101 | Hollow Reamer 1.5mm | 1 |
| 2 | 3128-0102 | Hollow Reamer 2.0mm | 1 |
| 3 | 3128-0103 | Screwdriver for 1.5mm Screw | 1 |
| 4 | 3128-0104 | Screwdriver for 2.0mm Screw | 1 |
| 5 | 3128-0105 | Depth Gauge 0-30mm | 1 |
| 6 | 3128-0106 | Limited Drill Bit 1.6*5mm | 1 |
| | 3128-0107 | Limited Drill Bit 1.6*6mm | 1 |
| | 3128-0108 | Limited Drill Bit 1.6*7mm | 1 |
| | 3128-0109 | Limited Drill Bit 1.6*9mm | 1 |
| | 3128-0110 | Limited Drill Bit 1.6*11mm | 1 |
| | 3128-0111 | Limited Drill Bit 1.6*13mm | 1 |
| | 3128-0112 | Limited Drill Bit 1.6*15mm | 1 |
| 7 | 3128-0113 | Limited Drill Bit 1.1*4mm | 1 |
| | 3128-0114 | Limited Drill Bit 1.1*5mm | 1 |
| | 3128-0115 | Limited Drill Bit 1.1*6mm | 1 |
| | 3128-0116 | Limited Drill Bit 1.1*7mm | 1 |
| | 3128-0117 | Limited Drill Bit 1.1*9mm | 1 |
| | 3128-0118 | Limited Drill Bit 1.1*11mm | 1 |
| 8 | 3128-0119 | Quick Coupling Handle | 1 |
| 9 | 3128-0120 | Guider 1.1mm & 1.6mm | 1 |
| 10 | 3128-0121 | Aluminium Box | 1 |

1,5/2,0 mm Maxillofacial Plate Instrument Set



| | | | |
|----|-----------|-----------------------------|---|
| 1 | 3128-0201 | Depth Gauge 0-30mm | 1 |
| 2 | 3128-0202 | Quick Coupling Handle | 1 |
| 3 | 3128-0203 | Guider 1.9mm | 1 |
| 4 | 3128-0204 | Countersink Drill 2.0mm | 1 |
| 5 | 3128-0205 | Screwdriver for 2.4mm Screw | 1 |
| | 3128-0206 | Limited Drill Bit 1.9*5mm | 1 |
| | 3128-0207 | Limited Drill Bit 1.9*7mm | 1 |
| 6 | 3128-0208 | Limited Drill Bit 1.9*9mm | 1 |
| | 3128-0209 | Limited Drill Bit 1.9*11mm | 1 |
| | 3128-0210 | Limited Drill Bit 1.9*13mm | 1 |
| | 3128-0211 | Limited Drill Bit 1.9*15mm | 1 |
| 7 | 3128-0212 | Plate Shaping Forcep Round | 1 |
| 8 | 3128-0213 | Plate Shaping Forcep Round | 1 |
| 9 | 3128-0214 | Plate Bender | 1 |
| 10 | 3128-0215 | Plate Bender | 1 |
| 11 | 3128-0216 | Plate Shaping Forcep | 1 |
| 12 | 3128-0217 | Aluminium Box | 1 |

Screw Removal Instrument Set

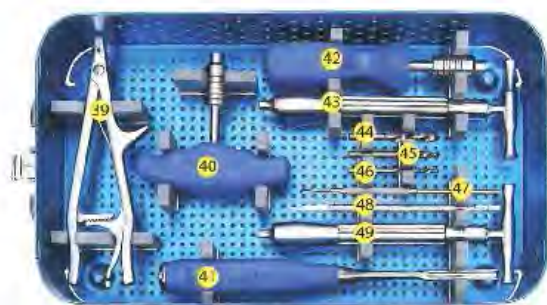
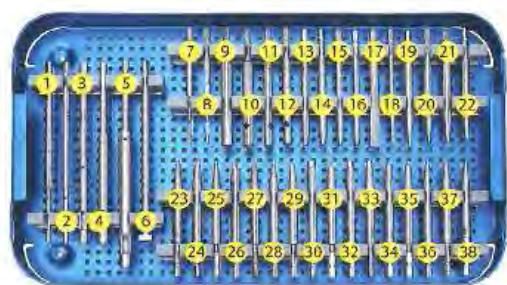

| | | | |
|----|-----------|--|---|
| 1 | 4200-1001 | Hollow Reamer Φ 4 | 1 |
| 2 | 4200-1002 | Hollow Reamer Φ 5 | 1 |
| 3 | 4200-1003 | Hollow Reamer Φ 6.5 | 1 |
| 4 | 4200-1004 | Hollow Reamer Φ 8 | 1 |
| 5 | 4200-1005 | Hollow Reamer Φ 10 | 1 |
| 6 | 4200-1006 | Spinal Monoaxial Pedicle Screwdriver | 1 |
| 7 | 4200-1007 | Hollow Reamer Φ 3.0 | 1 |
| 8 | 4200-1008 | Hollow Reamer Φ 2.7 | 1 |
| 9 | 4200-1009 | Extraction Bolt Φ 6.5 | 1 |
| 10 | 4200-1010 | Extraction Bolt Φ 6.0 | 1 |
| 11 | 4200-1011 | Extraction Bolt Φ 4.5 | 1 |
| 12 | 4200-1012 | Extraction Bolt Φ 3.5 | 1 |
| 13 | 4200-1013 | Extraction Screw Hexagonal 4.0mm Conical | 1 |
| 14 | 4200-1014 | Extraction Screw Hexagonal 3.5mm Conical | 1 |
| 15 | 4200-1015 | Extraction Screw Hexagonal 2.5mm Conical | 1 |
| 16 | 4200-1016 | Extraction Screw Hexagonal 2.5*0.5mm Conical | 1 |
| 17 | 4200-1017 | Slotted Screwdriver Small | 1 |
| 18 | 4200-1018 | Slotted Screwdriver Large | 1 |
| 19 | 4200-1019 | Phillips Screwdriver | 1 |
| 20 | 4200-1020 | Square Screwdriver SW1.5 | 1 |
| 21 | 4200-1021 | Square Screwdriver SW1.2 | 1 |
| 22 | 4200-1022 | Square Screwdriver SW1.1 | 1 |
| 23 | 4200-1023 | Star Screwdriver T5.5 | 1 |
| 24 | 4200-1024 | Star Screwdriver T5.0 | 1 |
| 25 | 4200-1025 | Star Screwdriver T4.4 | 1 |
| 26 | 4200-1026 | Star Screwdriver T3.8 | 1 |
| 27 | 4200-1027 | Star Screwdriver T3.3 | 1 |
| 28 | 4200-1028 | Star Screwdriver T2.7 | 1 |
| 29 | 4200-1029 | Star Screwdriver T2.2 | 1 |
| 30 | 4200-1030 | Hexagonal Screwdriver SW5.5 | 1 |
| 31 | 4200-1031 | Hexagonal Screwdriver SW5.0 | 1 |
| 32 | 4200-1032 | Hexagonal Screwdriver SW4.5 | 1 |
| 33 | 4200-1033 | Hexagonal Screwdriver SW4.0 | 1 |
| 34 | 4200-1034 | Hexagonal Screwdriver SW3.5 | 1 |
| 35 | 4200-1035 | Hexagonal Screwdriver SW3.0 | 1 |
| 36 | 4200-1036 | Hexagonal Screwdriver SW2.5 | 1 |
| 37 | 4200-1037 | Hexagonal Screwdriver SW2.0 | 1 |
| 38 | 4200-1038 | Hexagonal Screwdriver SW1.5 | 1 |
| 39 | 4200-1039 | Pliers for Screw Removal | 1 |
| 40 | 4200-1040 | T-shaped Handle Quick Coupling | 1 |
| 41 | 4200-1041 | Round Gouge 8mm | 1 |
| 42 | 4200-1042 | Straight Handle Quick Coupling | 1 |
| 43 | 4200-1043 | Screw Extractor Φ 4.5 | 1 |
| 44 | 4200-1044 | High Speed Drill Bit Φ 8*36*75mm | 1 |
| 45 | 4200-1045 | High Speed Drill Bit Φ 6*36*75mm | 1 |
| 46 | 4200-1046 | High Speed Drill Bit Φ 4*36*75mm | 1 |
| 47 | 4200-1047 | Sharp Hook | 1 |
| 48 | 4200-1048 | Tip Screwdriver | 1 |
| 49 | 4200-1049 | Screw Extractor Φ 3.5 | 1 |
| 50 | 4200-1050 | Aluminium Box | 1 |

Titanium Mesh Instrument Set

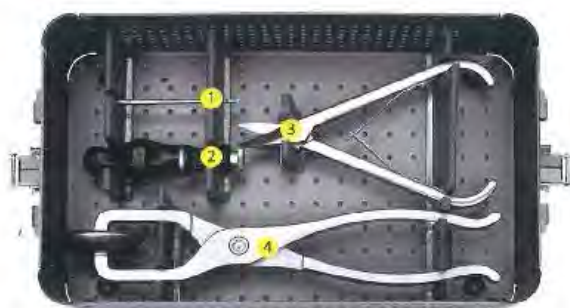

| | | | |
|---|-----------|---------------------------------|---|
| 1 | 3128-0301 | Screwdriver for 2.0mm Screw | 1 |
| 2 | 3128-0302 | Aluminium Handle Quick Coupling | 1 |
| 3 | 3128-0303 | Mesh Cutter | 1 |
| 4 | 3128-0304 | Shaping Forcep | 1 |
| 5 | 3128-0305 | Aluminium Box | 1 |

Rib Plate Instrument Set

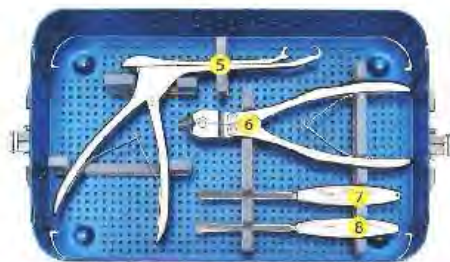
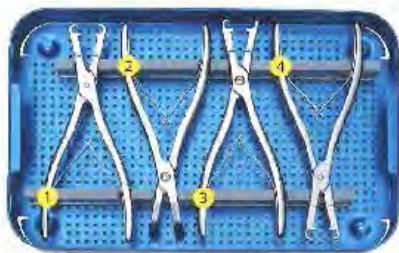

| | | | |
|---|-----------|-------------------------------|---|
| 1 | 4200-0901 | Reduction Forcep Double Large | 1 |
| 2 | 4200-0902 | Reduction Forcep Curved | 1 |
| 3 | 4200-0903 | Reduction Forcep Double Small | 1 |
| 4 | 4200-0904 | Reduction Forcep Single | 1 |
| 5 | 4200-0905 | Plate Insert Forcep | 1 |
| 6 | 4200-0906 | Rib Plate Cutter | 1 |
| 7 | 4200-0907 | Periosteal Elevator 9mm | 1 |
| 8 | 4200-0908 | Periosteal Elevator 12mm | 1 |
| 9 | 4200-0909 | Aluminium Box | 1 |

1,5/2,0 mm Maxillofacial Plate Instrument Set



1,5/2,0mm Maxillofacial Plate
Cutter & Bender L
3128-0123

1,5/2,0mm Maxillofacial Plate
Cutter & Bender R
3128-0122

| | | | |
|----|-----------|-----------------------------|---|
| 1 | 3128-0101 | Hollow Reamer 1.5mm | 1 |
| 2 | 3128-0102 | Hollow Reamer 2.0mm | 1 |
| 3 | 3128-0103 | Screwdriver for 1.5mm Screw | 1 |
| 4 | 3128-0104 | Screwdriver for 2.0mm Screw | 1 |
| 5 | 3128-0105 | Depth Gauge 0-30mm | 1 |
| 6 | 3128-0106 | Limited Drill Bit 1.6*5mm | 1 |
| | 3128-0107 | Limited Drill Bit 1.6*6mm | 1 |
| | 3128-0108 | Limited Drill Bit 1.6*7mm | 1 |
| | 3128-0109 | Limited Drill Bit 1.6*9mm | 1 |
| | 3128-0110 | Limited Drill Bit 1.6*11mm | 1 |
| | 3128-0111 | Limited Drill Bit 1.6*13mm | 1 |
| | 3128-0112 | Limited Drill Bit 1.6*15mm | 1 |
| 7 | 3128-0113 | Limited Drill Bit 1.1*4mm | 1 |
| | 3128-0114 | Limited Drill Bit 1.1*5mm | 1 |
| | 3128-0115 | Limited Drill Bit 1.1*6mm | 1 |
| | 3128-0116 | Limited Drill Bit 1.1*7mm | 1 |
| | 3128-0117 | Limited Drill Bit 1.1*9mm | 1 |
| | 3128-0118 | Limited Drill Bit 1.1*11mm | 1 |
| 8 | 3128-0119 | Quick Coupling Handle | 1 |
| 9 | 3128-0120 | Guider 1.1 mm & 1.6mm | 1 |
| 10 | 3128-0121 | Aluminium Box | 1 |

2,4 mm Maxillofacial Plate Instrument Set

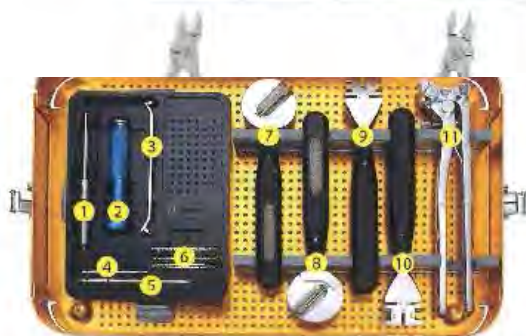

| | | | |
|----|-----------|-----------------------------|---|
| 1 | 3128-0201 | Depth Gauge 0-30mm | 1 |
| 2 | 3128-0202 | Quick Coupling Handle | 1 |
| 3 | 3128-0203 | Guider 1.9mm | 1 |
| 4 | 3128-0204 | Countersink Drill 2.0mm | 1 |
| 5 | 3128-0205 | Screwdriver for 2.4mm Screw | 1 |
| | 3128-0206 | Limited Drill Bit 1.9*5mm | 1 |
| | 3128-0207 | Limited Drill Bit 1.9*7mm | 1 |
| 6 | 3128-0208 | Limited Drill Bit 1.9*9mm | 1 |
| | 3128-0209 | Limited Drill Bit 1.9*11mm | 1 |
| | 3128-0210 | Limited Drill Bit 1.9*13mm | 1 |
| | 3128-0211 | Limited Drill Bit 1.9*15mm | 1 |
| 7 | 3128-0212 | Plate Shaping Forcep Round | 1 |
| 8 | 3128-0213 | Plate Shaping Forcep Round | 1 |
| 9 | 3128-0214 | Plate Bender | 1 |
| 10 | 3128-0215 | Plate Bender | 1 |
| 11 | 3128-0216 | Plate Shaping Forcep | 1 |
| 12 | 3128-0217 | Aluminium Box | 1 |

Screw Removal Instrument Set

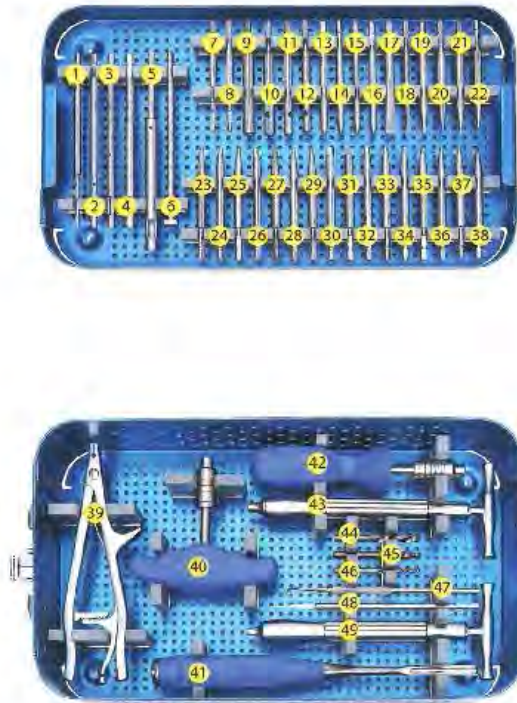

| | | | |
|----|-----------|--|---|
| 1 | 4200-1001 | Hollow Reamer Φ 4 | 1 |
| 2 | 4200-1002 | Hollow Reamer Φ 5 | 1 |
| 3 | 4200-1003 | Hollow Reamer Φ 6.5 | 1 |
| 4 | 4200-1004 | Hollow Reamer Φ 8 | 1 |
| 5 | 4200-1005 | Hollow Reamer Φ 10 | 1 |
| 6 | 4200-1006 | Spinal Monoaxial Pedicle Screwdriver | 1 |
| 7 | 4200-1007 | Hollow Reamer Φ 3.0 | 1 |
| 8 | 4200-1008 | Hollow Reamer Φ 2.7 | 1 |
| 9 | 4200-1009 | Extraction Bolt Φ 6.5 | 1 |
| 10 | 4200-1010 | Extraction Bolt Φ 6.0 | 1 |
| 11 | 4200-1011 | Extraction Bolt Φ 4.5 | 1 |
| 12 | 4200-1012 | Extraction Bolt Φ 3.5 | 1 |
| 13 | 4200-1013 | Extraction Screw Hexagonal 4.0mm Conical | 1 |
| 14 | 4200-1014 | Extraction Screw Hexagonal 3.5mm Conical | 1 |
| 15 | 4200-1015 | Extraction Screw Hexagonal 2.5mm Conical | 1 |
| 16 | 4200-1016 | Extraction Screw Hexagonal 2.5*0.5mm Conical | 1 |
| 17 | 4200-1017 | Slotted Screwdriver Small | 1 |
| 18 | 4200-1018 | Slotted Screwdriver Large | 1 |
| 19 | 4200-1019 | Phillips Screwdriver | 1 |
| 20 | 4200-1020 | Square Screwdriver SW1.5 | 1 |
| 21 | 4200-1021 | Square Screwdriver SW1.2 | 1 |
| 22 | 4200-1022 | Square Screwdriver SW1.1 | 1 |
| 23 | 4200-1023 | Star Screwdriver T5.5 | 1 |
| 24 | 4200-1024 | Star Screwdriver T5.0 | 1 |
| 25 | 4200-1025 | Star Screwdriver T4.4 | 1 |
| 26 | 4200-1026 | Star Screwdriver T3.8 | 1 |
| 27 | 4200-1027 | Star Screwdriver T3.3 | 1 |
| 28 | 4200-1028 | Star Screwdriver T2.7 | 1 |
| 29 | 4200-1029 | Star Screwdriver T2.2 | 1 |
| 30 | 4200-1030 | Hexagonal Screwdriver SW5.5 | 1 |
| 31 | 4200-1031 | Hexagonal Screwdriver SW5.0 | 1 |
| 32 | 4200-1032 | Hexagonal Screwdriver SW4.5 | 1 |
| 33 | 4200-1033 | Hexagonal Screwdriver SW4.0 | 1 |
| 34 | 4200-1034 | Hexagonal Screwdriver SW3.5 | 1 |
| 35 | 4200-1035 | Hexagonal Screwdriver SW3.0 | 1 |
| 36 | 4200-1036 | Hexagonal Screwdriver SW2.5 | 1 |
| 37 | 4200-1037 | Hexagonal Screwdriver SW2.0 | 1 |
| 38 | 4200-1038 | Hexagonal Screwdriver SW1.5 | 1 |
| 39 | 4200-1039 | Pliers for Screw Removal | 1 |
| 40 | 4200-1040 | T-shaped Handle Quick Coupling | 1 |
| 41 | 4200-1041 | Round Gouge 8mm | 1 |
| 42 | 4200-1042 | Straight Handle Quick Coupling | 1 |
| 43 | 4200-1043 | Screw Extractor Φ 4.5 | 1 |
| 44 | 4200-1044 | High Speed Drill Bit Φ 8*36*75mm | 1 |
| 45 | 4200-1045 | High Speed Drill Bit Φ 6*36*75mm | 1 |
| 46 | 4200-1046 | High Speed Drill Bit Φ 4*36*75mm | 1 |
| 47 | 4200-1047 | Sharp Hook | 1 |
| 48 | 4200-1048 | Tip Screwdriver | 1 |
| 49 | 4200-1049 | Screw Extractor Φ 3.5 | 1 |
| 50 | 4200-1050 | Aluminium Box | 1 |

Titanium Mesh Instrument Set

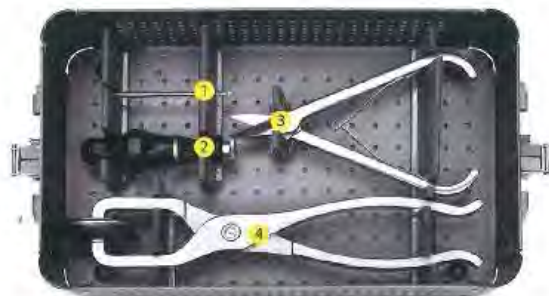

| | | | |
|---|-----------|---------------------------------|---|
| 1 | 3128-0301 | Screwdriver for 2.0mm Screw | 1 |
| 2 | 3128-0302 | Aluminium Handle Quick Coupling | 1 |
| 3 | 3128-0303 | Mesh Cutter | 1 |
| 4 | 3128-0304 | Shaping Forcep | 1 |
| 5 | 3128-0305 | Aluminium Box | 1 |

Intramedullary Nail Removal Instrument Set

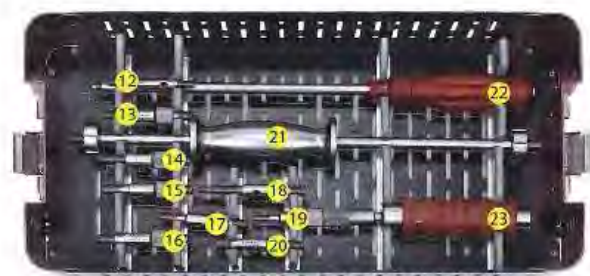
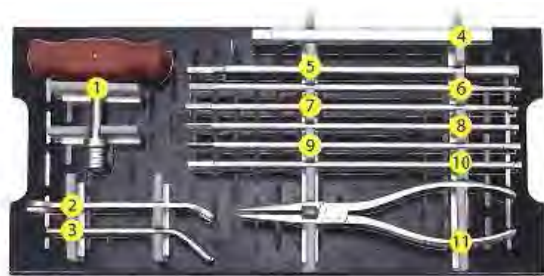

| | | | |
|----|-----------|--|---|
| 1 | 1200-1201 | T-handle Quick Coupling | 1 |
| 2 | 1200-1202 | Wrench | 2 |
| 3 | 1200-1203 | Open Wrench T1.5 | 1 |
| 4 | 1200-1204 | End Cap Wrench 180mm | 1 |
| 5 | 1200-1205 | Locking Screw Extractor 250mm | 1 |
| 6 | 1200-1206 | Hex Screwdriver SW2.5*250mm | 1 |
| 7 | 1200-1207 | Hex Screwdriver SW3.5*250mm | 1 |
| 8 | 1200-1208 | Hex Screwdriver SW4.0*250mm | 1 |
| 9 | 1200-1209 | Hex Screwdriver SW4.5*250mm | 1 |
| 10 | 1200-1210 | Hex Screwdriver SW5.0*250mm | 1 |
| 11 | 1200-1211 | Wire Cutter | 1 |
| 12 | 1200-1212 | Saw Blade Extractor Chuck SW4.0 Right/Left | 2 |
| 13 | 1200-1213 | Extractor Chuck M8*1mm | 1 |
| 14 | 1200-1214 | Extractor Chuck M8 | 1 |
| 15 | 1200-1215 | Extractor Chuck M10 | 1 |
| 16 | 1200-1216 | Extractor Chuck M10*1mm | 1 |
| 17 | 1200-1217 | Extractor Chuck Universal Large | 1 |
| 18 | 1200-1218 | Extractor Chuck M11 | 1 |
| 19 | 1200-1219 | Extractor Chuck M6 | 1 |
| 20 | 1200-1220 | Extractor Chuck Universal Small | 1 |
| 21 | 1200-1221 | Hammer | 1 |
| 22 | 1200-1222 | Saw Blade Driver | 1 |
| 23 | 1200-1223 | Universal Joint | 1 |
| 24 | 1200-1224 | Aluminium Box | 1 |

Flexible Reamer Set

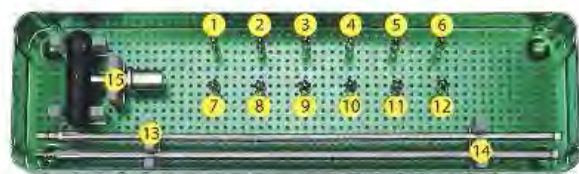

| | | | |
|----|-----------|-------------------------|---|
| 1 | 1200-1001 | Reamer Head $\Phi 7.5$ | 1 |
| 2 | 1200-1002 | Reamer Head $\Phi 8$ | 1 |
| 3 | 1200-1003 | Reamer Head $\Phi 8.5$ | 1 |
| 4 | 1200-1004 | Reamer Head $\Phi 9$ | 1 |
| 5 | 1200-1005 | Reamer Head $\Phi 9.5$ | 1 |
| 6 | 1200-1006 | Reamer Head $\Phi 10$ | 1 |
| 7 | 1200-1007 | Reamer Head $\Phi 10.5$ | 1 |
| 8 | 1200-1008 | Reamer Head $\Phi 11$ | 1 |
| 9 | 1200-1009 | Reamer Head $\Phi 11.5$ | 1 |
| 10 | 1200-1010 | Reamer Head $\Phi 12$ | 1 |
| 11 | 1200-1011 | Reamer Head $\Phi 12.5$ | 1 |
| 12 | 1200-1012 | Reamer Head $\Phi 13$ | 1 |
| 13 | 1200-1013 | Bar 7.5mm | 1 |
| 14 | 1200-1014 | Bar 8.5mm | 1 |
| 15 | 1200-1015 | Quick Coupling T-Handle | 1 |
| 16 | 1200-1016 | Aluminium Box | 1 |

Flexible Reamer



| | | | |
|-----------|--------------------|-----------|--------------------|
| 1200-1101 | Reamer $\Phi 7.5$ | 1200-1108 | Reamer $\Phi 11$ |
| 1200-1102 | Reamer $\Phi 8$ | 1200-1109 | Reamer $\Phi 11.5$ |
| 1200-1103 | Reamer $\Phi 8.5$ | 1200-1110 | Reamer $\Phi 12$ |
| 1200-1104 | Reamer $\Phi 9$ | 1200-1111 | Reamer $\Phi 12.5$ |
| 1200-1105 | Reamer $\Phi 9.5$ | 1200-1112 | Reamer $\Phi 13$ |
| 1200-1106 | Reamer $\Phi 10$ | 1200-1113 | Reamer $\Phi 13.5$ |
| 1200-1107 | Reamer $\Phi 10.5$ | 1200-1114 | Reamer $\Phi 14$ |

Olive Guide Wire



1200-1115

2.5mm Diameter*1m Length

Intramedullary Nail Removal Instrument Set

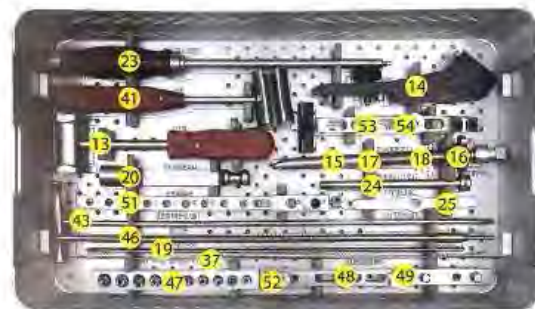
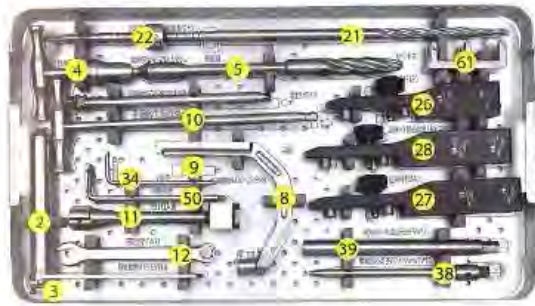
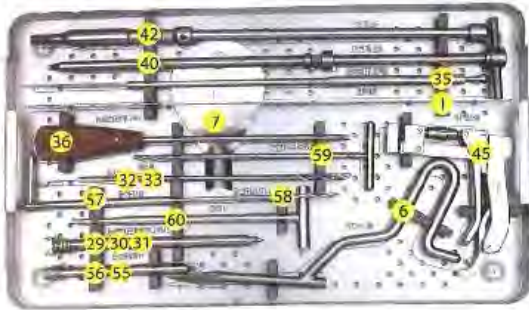

| | | | |
|----|-----------|---|---|
| 1 | 1200-0701 | Template for Development | 1 |
| 2 | 1200-0702 | Guide Sleeve $\phi 16.5$ | 1 |
| 3 | 1200-0703 | Guide Pin Sleeve $\phi 16.5/\phi 3.2$ | 1 |
| 4 | 1200-0704 | Handle with Quick Coupling | 1 |
| 5 | 1200-0705 | Proximal Hollow Drill Bit $\phi 16.5/\phi 3.2$ | 1 |
| 6 | 1200-0706 | Hollow Open Tapper | 1 |
| 7 | 1200-0707 | Protected Platefor Soft Tissue | 1 |
| 8 | 1200-0708 | Handle | 1 |
| 9 | 1200-0709 | Connecting Bolt M10*1.5/SW8 | 1 |
| 10 | 1200-0710 | Universal Wrench of Connecting Bolt SW8 | 1 |
| 11 | 1200-0711 | Main Pin Impactor | 1 |
| 12 | 1200-0712 | Open Wrench SW11 | 1 |
| 13 | 1200-0713 | Impactor Hammer | 1 |
| 14 | 1200-0714 | Proximal Guide Bar | 1 |
| 15 | 1200-0715 | Guide Sleeve $\phi 11.2$ | 1 |
| 16 | 1200-0716 | Support/Compression Nut | 1 |
| 17 | 1200-0717 | Guide Sleeve for Pins $\phi 11.2/\phi 3.2$ | 1 |
| 18 | 1200-0718 | Pins $\phi 3.2$ | 1 |
| 19 | 1200-0719 | Thread Pin $\phi 3.2*400\text{mm}$ | 1 |
| 20 | 1200-0720 | Depth Gauge $\phi 3.2$ | 1 |
| 21 | 1200-0721 | Proximal Hollow Position Stopper $\phi 10.6/\phi 3.2$ | 1 |
| 22 | 1200-0722 | Position Stopper | 1 |
| 23 | 1200-0723 | Screwdriver M7*1 L/SW4.5/ $\phi 3.2$ | 1 |
| 24 | 1200-0724 | Connector | 1 |
| 25 | 1200-0725 | Wrench | 1 |
| 26 | 1200-0726 | Distal Guide Bar 180 | 1 |
| 27 | 1200-0727 | Distal Guide Bar 240 | 1 |
| 28 | 1200-0728 | Distal 90 Degree Guide Bar 180/240 | 1 |
| 29 | 1200-0729 | Distal Locking Pin Sleeve $\phi 11/\phi 8.2$ | 1 |
| 30 | 1200-0730 | Soft Tissue Separating Device $\phi 8.2/\phi 4.3$ | 1 |
| 31 | 1200-0731 | Sleeve Pin $\phi 4.3$ | 1 |
| 32 | 1200-0732 | Drill Bit $\phi 4.3$ | 1 |
| 33 | 1200-0733 | Position Stopper $\phi 4.3/\text{SW}3$ | 1 |
| 34 | 1200-0734 | Small Wrench SW3/ $\phi 4$ | 1 |
| 35 | 1200-0735 | Distal Locking Holes Depth Gauge | 1 |
| 36 | 1200-0736 | Distal Locking Screw Wrench SW4 | 1 |
| 37 | 1200-0737 | Tail Hook Guide Pin $\phi 2.8$ | 1 |
| 38 | 1200-0738 | Tail Hollow Screwdriver $\phi 2.8/\text{SW}6.5/\text{SW}11$ | 1 |
| 39 | 1200-0739 | Tail Hollow Sleeve/Extension Rod SW11 | 1 |
| 40 | 1200-0740 | Blade Nail Device M7*1 L/SW4.5 | 1 |
| 41 | 1200-0741 | Sliding Hammer | 1 |
| 42 | 1200-0742 | Nail Remove Rod M10*1.5 | 1 |
| 43 | 1200-0743 | Reduction Rod (Guide Pin Leading Device) | 1 |
| 44 | 1200-0744 | Ball Head Guide Pin $\phi 2.5/\phi 4$ | 1 |
| 45 | 1200-0745 | Guide Pin Control Device | 1 |
| 46 | 1200-0746 | Soft Expansion Tool Rod $\phi 2.5/\phi 8$ | 1 |
| 47 | 1200-0747 | Soft Expansion Metallutgy $\phi 8-\phi 13$ | 1 |
| 48 | 1200-0748 | Long Nail Distal Connection Guide Pin | 1 |
| 49 | 1200-0749 | Long Nail Distal Connection Guide Bar Lock Wheels M8*1/SW5 | 1 |
| 50 | 1200-0750 | Locking Wheel Spanner | 1 |
| 51 | 1200-0751 | Long Nail Distal Guide Bar | 1 |
| 52 | 1200-0752 | Long Nail Distal Guide Pin Locking Wheels M8*1/SW5 | 1 |
| 53 | 1200-0753 | Long Nail Distal Positioning Frame | 1 |
| 54 | 1200-0754 | Long Nail Distal Positioning Frame Lock Wheels M6/SW5 | 1 |
| 55 | 1200-0755 | Positioning Pipe $\phi 10/\phi 8.1$ | 1 |
| 56 | 1200-0756 | Positioning Stem Bushing Needle $\phi 8.1$ | 1 |
| 57 | 1200-0757 | Positioning Stem Drilling Sheath $\phi 8.1/\phi 5.2$ | 1 |
| 58 | 1200-0758 | Positioning Drill Rod $\phi 5.2$ | 1 |
| 59 | 1200-0759 | Positioning Stem Flats Drill $\phi 5.2$ | 1 |
| 60 | 1200-0760 | Positioning Rod $\phi 8.1/\phi 5.2$ | 1 |
| 61 | 1200-0761 | Positioning Card | 1 |
| 62 | 1200-0762 | Aluminium Box | 1 |

4,0 mm Cannulated Screw Instrument Set

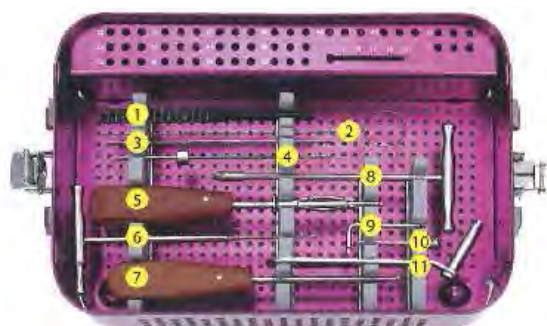

| | | | |
|----|-----------|---|---|
| 1 | 4200-0601 | Depth Gauge (0-80mm) | 1 |
| 2 | 4200-0602 | Cleaning Stylet 1.2mm | 1 |
| 3 | 4200-0603 | Threaded Guider Wire 1.2mm | 4 |
| 4 | 4200-0604 | Cannulated Drill Bit with Limited Block 2.7mm | 1 |
| 5 | 4200-0605 | Screwdriver Hexagonal 2.5mm | 1 |
| 6 | 4200-0606 | Cannulated Tap Cannulated Screw 4.0mm | 1 |
| 7 | 4200-0607 | Cannulated Screwdriver Hexagonal 2.5mm | 1 |
| 8 | 4200-0608 | Cannulated Countersink Ø6.5 | 1 |
| 9 | 4200-0609 | Hex Key | 1 |
| 10 | 4200-0610 | Drill Sleeve 1.2mm | 1 |
| 11 | 4200-0611 | Protection Sleeve | 1 |
| 12 | 4200-0612 | Aluminium Box | 1 |

6,5 mm Cannulated Screw Instrument Set

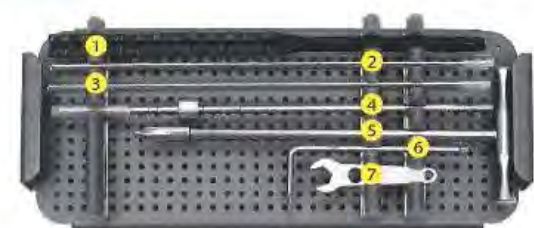

| | | | |
|----|-----------|---|---|
| 1 | 4200-0701 | Depth Gauge(0-120mm) | 1 |
| 2 | 4200-0702 | Threaded Guider Wire 2.5mm | 2 |
| 3 | 4200-0703 | Threaded Guider Wire 2.5mm | 2 |
| 4 | 4200-0704 | Cannulated Drill Bit with Limited Block 4.5mm | 1 |
| 5 | 4200-0705 | Cannulated Countersink Ø9 | 1 |
| 6 | 4200-0706 | Hex Key | 1 |
| 7 | 4200-0707 | Wrench for Adjustable Parallel Wire Guider | 1 |
| 8 | 4200-0708 | Multiple Wire Guider | 1 |
| 9 | 4200-0709 | Tap Cannulated Screw 6.5mm | 1 |
| 10 | 4200-0710 | Screwdriver Hexagonal 3.5mm | 1 |
| 11 | 4200-0711 | Cleaning Stylet 2.5mm | 1 |
| 12 | 4200-0712 | Drill Sleeve | 1 |
| 13 | 4200-0713 | Adjustable Parallel Wire Guider | 1 |
| 14 | 4200-0714 | Cannulated Screwdriver Hexagonal 3.5mm | 1 |
| 15 | 4200-0715 | Aluminium Box | 1 |

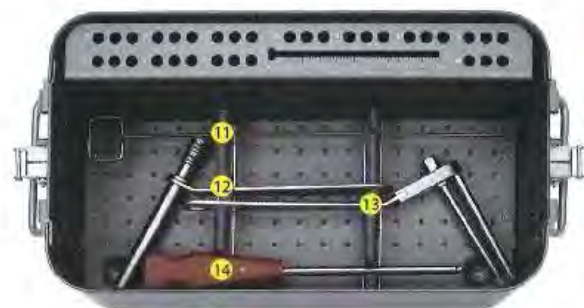

Collinear Reduction Clamp Instrument Set

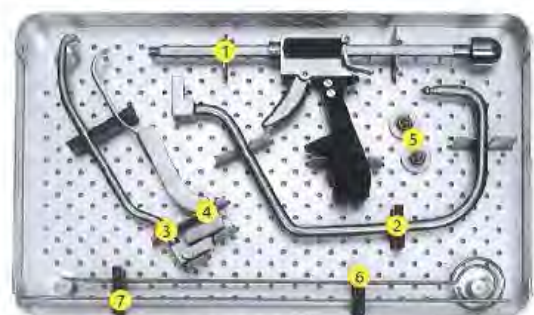

| | | | |
|---|-----------|-------------------------|--|
| 1 | 4200-1101 | Handpiece | |
| 2 | 4200-1102 | Percutaneous Arm 255mm | |
| 3 | 4200-1103 | Pelvic Arm 225mm | |
| 4 | 4200-1104 | Hohmann-style Arm 183mm | |
| 5 | 4200-1105 | Protect Sleeve | |
| 6 | 4200-1106 | Clean Pin | |
| 6 | 4200-1107 | Clean Brush | |
| 7 | 4200-1108 | Threaded K-wire | |
| 7 | 4200-1109 | K-wire | |
| 8 | 4200-1110 | Aluminium Box | |

DHS/DCS Plate Instrument Set

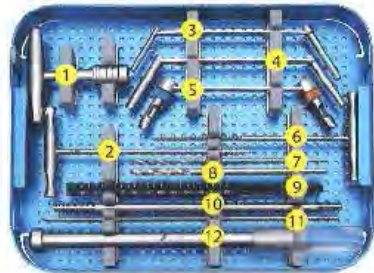
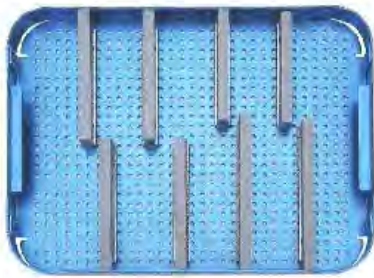

| | | | |
|----|-----------|-----------------------------------|---|
| 1 | 4200-0501 | T-handle Quick Coupling | 1 |
| 2 | 4200-0502 | Tap Cortical 4.5mm | 1 |
| 3 | 4200-0503 | Double Drill Sleeve (Φ4.5/Φ6.5) | 1 |
| 4 | 4200-0504 | Double Drill Sleeve(Φ4.5/Φ3.2) | 1 |
| 5 | 4200-0505 | Neutral and Load Drill Guide Φ2.5 | 1 |
| 6 | 4200-0506 | Tap Cancellous 6.5mm | 1 |
| 7 | 4200-0507 | Drill Bit Φ4.5*150mm | 2 |
| 8 | 4200-0508 | Drill Bit Φ3.2*150mm | 2 |
| 9 | 4200-0509 | Lag Screw Depth Measuring Device | 1 |
| 10 | 4200-0510 | Tap Cancellous 12mm | 1 |
| 11 | 4200-0511 | Threaded K-wire Φ2.5*225mm | 3 |
| 12 | 4200-0512 | DHS/DCS Impactor Large | 1 |
| 13 | 4200-0513 | Depth Gauge(0-100mm) | 1 |
| 14 | 4200-0514 | DHS/DCS Impactor Small | 1 |
| 15 | 4200-0515 | DHS/DCS Wrench, Purple Sleeve | 1 |
| 16 | 4200-0516 | DHS/DCS Wrench, Golden Sleeve | 1 |
| 17 | 4200-0517 | Screwdriver Hexagonal 3.5mm | 1 |
| 18 | 4200-0518 | DCS Angle Guide 95 Degree | 1 |
| 19 | 4200-0519 | DHS Angle Guier 135 degree | 1 |
| 20 | 4200-0520 | DHS Reamer | 1 |
| 21 | 4200-0521 | DCS Reamer | 1 |
| 22 | 4200-0522 | Aluminium Box | 1 |

Pelvic Reconsruction Plate Instrument Set

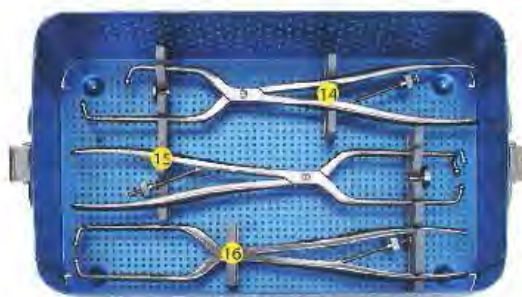
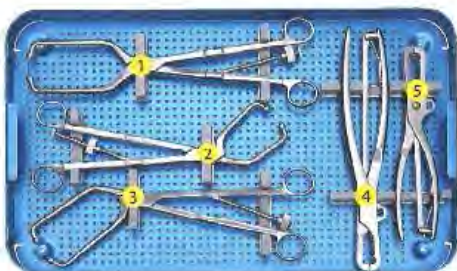

| | | | |
|----|-----------|--|---|
| 1 | 4200-0801 | Pelvic Reduction Forcep 280mm | 1 |
| 2 | 4200-0802 | Angled Pelvic Reduction Forcep 250mm | 1 |
| 3 | 4200-0803 | Angled Pelvic Reduction Forcep 280mm | 1 |
| 4 | 4200-0804 | Pelvic Reduction Forcep Medium 250mm | 1 |
| 5 | 4200-0805 | Pelvic Reduction Forcep Small 200mm | 1 |
| 6 | 4200-0806 | Plate Bender | 1 |
| 7 | 4200-0807 | Drill Guider 2.5 for Flexible Drill Bit | 1 |
| 8 | 4200-0808 | Pelvic Reduction Forcep Large 330mm | 1 |
| 9 | 4200-0809 | Straight Ball Spike 300mm | 1 |
| 10 | 4200-0810 | Straight Ball Spike 300mm | 1 |
| 11 | 4200-0811 | Tap Cortex 3.5mm | 1 |
| 12 | 4200-0812 | Flexibile Drill Bit Φ2.5 | 1 |
| 13 | 4200-0813 | Universal Screwdriver Hexagonal 2.5mm | 1 |
| 14 | 4200-0814 | Pelvic Asymmetric Reduction Forcep with Spiked Disc Round Curved/ Flat | 1 |
| 15 | 4200-0815 | Pelvic Reduction Forcep 400mm | 1 |
| 16 | 4200-0816 | Pelvic Reduction Forcep with 3 Ball-tiped | 1 |
| 17 | 4200-0817 | Aluminium Box | 1 |

Herbert Cannulated Screw Instrument Set

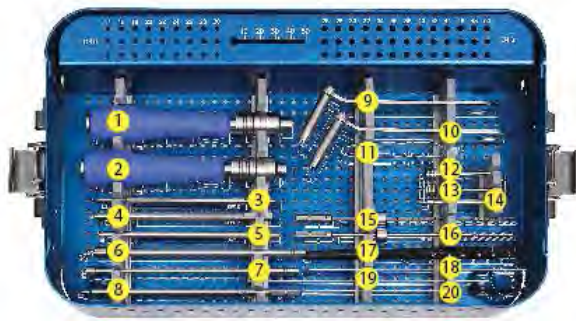

- 00-1155-011-00 Cannulated Tap, 4.5mm 1
- 00-1155-012-00 Cannulated Screwdriver, 4.5mm 1
- 00-1155-013-00 Trepine, 4.5mm 1
- 00-1155-014-00 Pilot Drill Bit, 3.8mm 1
- 00-1155-015-00 Main Drill Bit, 3.1mm 1
- 00-1155-016-00 Guide Pin, Partially Threaded, 1.6mm 1
- 00-1155-021-00 Cannulated Tap, 6.5mm 1
- 00-1155-022-00 Cannulated Screwdriver, 6.5mm 1
- 00-1155-023-00 Trepine 1
- 00-1155-024-00 Pilot Drill Bit, 5.5mm 1
- 00-1155-026-00 Guide Pin, Partially Threaded, 2.0mm 1
- 00-1155-027-00 Main Drill Bit, 4.6mm 1 •
- 00-1180-040-00 Depth Guide 1 •
- 00-4808-020-00 Parallel Drill Guide, 2.0mm 1
- 00-1155-085-00 Sterilization Tray 1

Headless Cannulated Screw Set



- 60.226.60 4.5 mm Headless Compression Screw Graphic Case
- 60.226.61 Screw Rack for 4.5 mm Headless Compression Screws
- 03.226.030 Measuring Device,for 4.5 mm Headless Compression Screws
- 03.226.033 Compression Sleeve,for 4.5 mm Headless Compression Screws
- 03.226.034 Sleeve for Compression Sleeve Handle,for 4.5 mm
- 03.226.037 Headless Compression Screws
- 03.226.037 Compression Sleeve Attachment, for 4.5 mm Headless Compression Screws
- 03.226.038 3.2 mm Cannulated Drill Bit
- 03.226.040 Cannulated Tap
- 03.226.041 Cannulated StarDrive Screwdriver,T15
- 03.226.042 4.0 mm Cannulated Drill Bit
- 311.44 T-Handle,with quick coupling
- 312.74 1.6 mm Trocar
- 312.75 3.2 mm/1.6 mm Drill Sleeve
- 312.76 7.0 mm/3.2 mm Drill Sleeve
- 312.77 9.5 mm/7.0 mm Protection Sleeve
- 314.116 StarDrive Screwdriver Shaft,quick coupling, T15
- 319.26 1.75 mm Cleaning Brush
- 319.35 1.6 mm Cleaning Stylet

Screw Removal Instrument Set

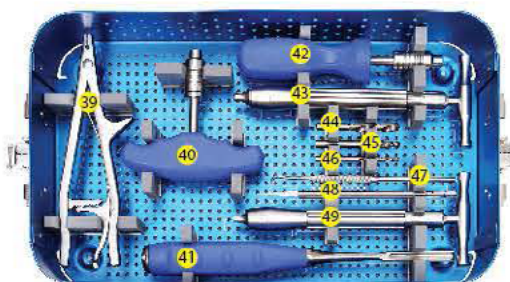
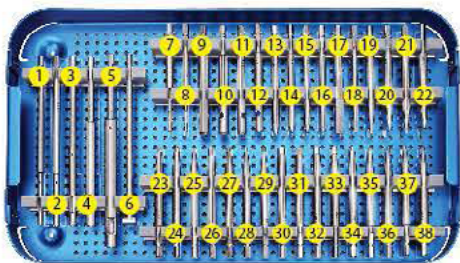

| | | | |
|----|-----------|--|---|
| 1 | 4200-1001 | Hollow Reamer Φ4 | 1 |
| 2 | 4200-1002 | Hollow Reamer Φ5 | 1 |
| 3 | 4200-1003 | Hollow Reamer Φ6.5 | 1 |
| 4 | 4200-1004 | Hollow Reamer Φ8 | 1 |
| 5 | 4200-1005 | Hollow Reamer Φ10 | 1 |
| 6 | 4200-1006 | Spinal Monoaxial Pedicle Screwdriver | 1 |
| 7 | 4200-1007 | Hollow Reamer Φ3.0 | 1 |
| 8 | 4200-1008 | Hollow Reamer Φ2.7 | 1 |
| 9 | 4200-1009 | Extraction Bolt Φ6.5 | 1 |
| 10 | 4200-1010 | Extraction Bolt Φ6.0 | 1 |
| 11 | 4200-1011 | Extraction Bolt Φ4.5 | 1 |
| 12 | 4200-1012 | Extraction Bolt Φ3.5 | 1 |
| 13 | 4200-1013 | Extraction Screw Hexagonal 4.0mm Conical | 1 |
| 14 | 4200-1014 | Extraction Screw Hexagonal 3.5mm Conical | 1 |
| 15 | 4200-1015 | Extraction Screw Hexagonal 2.5mm Conical | 1 |
| 16 | 4200-1016 | Extraction Screw Hexagonal 2.5*0.5mm Conical | 1 |
| 17 | 4200-1017 | Slotted Screwdriver Small | 1 |
| 18 | 4200-1018 | Slotted Screwdriver Large | 1 |
| 19 | 4200-1019 | Phillips Screwdriver | 1 |
| 20 | 4200-1020 | Square Screwdriver SW1.5 | 1 |
| 21 | 4200-1021 | Square Screwdriver SW1.2 | 1 |
| 22 | 4200-1022 | Square Screwdriver SW1.1 | 1 |
| 23 | 4200-1023 | Star Screwdriver T5.5 | 1 |
| 24 | 4200-1024 | Star Screwdriver T5.0 | 1 |
| 25 | 4200-1025 | Star Screwdriver T4.4 | 1 |
| 26 | 4200-1026 | Star Screwdriver T3.8 | 1 |
| 27 | 4200-1027 | Star Screwdriver T3.3 | 1 |
| 28 | 4200-1028 | Star Screwdriver T2.7 | 1 |
| 29 | 4200-1029 | Star Screwdriver T2.2 | 1 |
| 30 | 4200-1030 | Hexagonal Screwdriver SW5.5 | 1 |
| 31 | 4200-1031 | Hexagonal Screwdriver SW5.0 | 1 |
| 32 | 4200-1032 | Hexagonal Screwdriver SW4.5 | 1 |
| 33 | 4200-1033 | Hexagonal Screwdriver SW4.0 | 1 |
| 34 | 4200-1034 | Hexagonal Screwdriver SW3.5 | 1 |
| 35 | 4200-1035 | Hexagonal Screwdriver SW3.0 | 1 |
| 36 | 4200-1036 | Hexagonal Screwdriver SW2.5 | 1 |
| 37 | 4200-1037 | Hexagonal Screwdriver SW2.0 | 1 |
| 38 | 4200-1038 | Hexagonal Screwdriver SW1.5 | 1 |
| 39 | 4200-1039 | Pliers for Screw Removal | 1 |
| 40 | 4200-1040 | T-shaped Handle Quick Coupling | 1 |
| 41 | 4200-1041 | Round Gouge 8mm | 1 |
| 42 | 4200-1042 | Straight Handle Quick Coupling | 1 |
| 43 | 4200-1043 | Screw Extractor Φ4.5 | 1 |
| 44 | 4200-1044 | High Speed Drill Bit Φ8*36*75mm | 1 |
| 45 | 4200-1045 | High Speed Drill Bit Φ6*36*75mm | 1 |
| 46 | 4200-1046 | High Speed Drill Bit Φ4*36*75mm | 1 |
| 47 | 4200-1047 | Sharp Hook | 1 |
| 48 | 4200-1048 | Tip Screwdriver | 1 |
| 49 | 4200-1049 | Screw Extractor Φ3.5 | 1 |
| 50 | 4200-1050 | Aluminium Box | 1 |

Angled Blade Plate Instrument Set

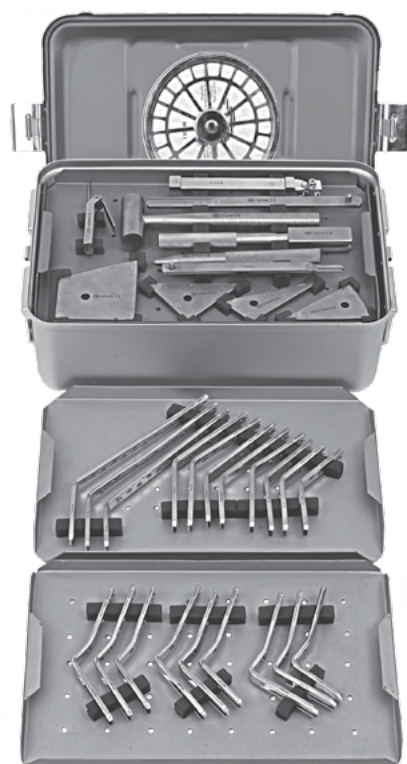

- 60.226.51 Seating Chisel for Adult
- 60.226.52 Seating Chisel for Infants
- 60.226.53 Seating Chisel for Adolescent and children
- 60.226.54 Inserter - Extractor for Adolescent and Children
- 60.226.55 Inserter-Extractor for adults
- 60.226.56 Impactor for angular plates
- 60.226.57 Slotted Hammer
- 60.226.58 Chisel Guide
- 60.226.59 Traingular Positioning Plate 80/70/30
- 60.226.591 Chisel Guide
- 60.226.592 Traingular Positioning Plate 90/50/40
- 60.226.593 Quadrangular Positioning Plate 110/90/90/70
- 60.226.594 Quadrangular Positioning Plate 100/60/20



Ayfix External Fixator Instrument Set

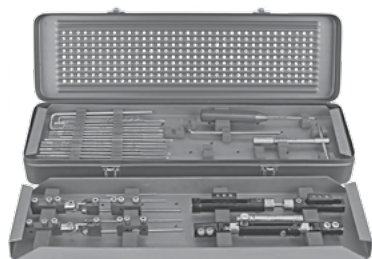

- Trocar
- Hexagonal Wrench 6.0 mm
- Hexagonal Wrench 4.0 mm
- Hexagonal Wrench 5.0 mm
- Sleeve Guide
- Drill Guide
- Drill Guide and Sleeve Guide
- T-Wrench (Quick Coupling Drill)
- Wrench
- T-Handle with Jacob's Chuck
- T-Handle Shaft
- T-Handle Adapter 4.0 /5.0/6.0 mm
- Two Side Open Wrench
- Single Side Open Wrench
- One Side Open One Side Circular Wrench
- Drill Bit with Stopper
- Long Bone Drill



Mini Rail Instrument Set



T-Wrench for bone screw
Threaded wire Ø1,6 mm (pack of 4) total length 40 mm, thread length 15 mm
Threaded wire Ø2,0 mm (pack of 4) total length 45 mm, thread length 20 mm
Threaded wire exterator
Allen wrench 3 mm
T-wrench for clamp screws
Drill Sleeve 2,0/2,5 mm
Bone Drill 1,6/2,0 mm

Tubular Fixator Instrument Set



Hoffmann External
Fixation Small
Fragment Set
1 7100-0101 Rod-Rod Coupling (5mm Rod) 12
2 7100-0102 Rod-Pin Coupling (3/4mm Pin, 5mm Rod) 12
3 7100-0103 4-Hole Pin Clamp (3/4mm Pin) 3
4 7100-0104 Pin Clamp (3/4mm Pin) 1
5 7100-0105 Straight Post 2
6 7100-0106 30 Degree Angled Post 4
7 7100-0107 Apex Pin Self-drilling 3*80mm 4
8 7100-0108 Apex Pin Self-drilling 3*100mm 4
9 7100-0109 Apex Pin Self-drilling 4*80mm 4
10 7100-0110 Apex Pin Self-drilling 4*100mm 4
11 7100-0111 Apex Pin Self-drilling 4*120mm 4
12 7100-0112 Drill Sleeve 3mm 1
13 7100-0113 Drill Sleeve 4mm 1
14 7100-0114 Carbon Fiber Connecting Rod 5*120mm 4
15 7100-0115 Carbon Fiber Connecting Rod 5*150mm 4
16 7100-0116 Carbon Fiber Connecting Rod 5*180mm 2
17 7100-0117 Carbon Fiber Connecting Rod 5*200mm 4
18 7100-0118 T-shaped Clamp Wrench 5# 1
19 7100-0119 Reduction Wrench 1
20 7100-0120 Elbow Joint 5mm 1
21 7100-0121 Apex Pin Chuck 3mm 1
22 7100-0122 Apex Pin Chuck 4mm 1
23 7100-0123 T-shaped Pin Wrench 3mm 1
24 7100-0124 T-shaped Pin Wrench 4mm 1
25 7100-0125 Arc Drilling Stand 1
26 7100-0126 Adjust Wheel 1
27 7100-0127 Aluminum Box 1

Hybrid Fixator Instrument Set

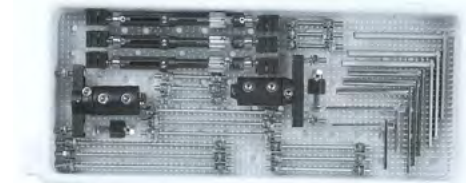
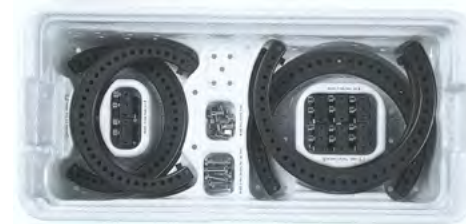
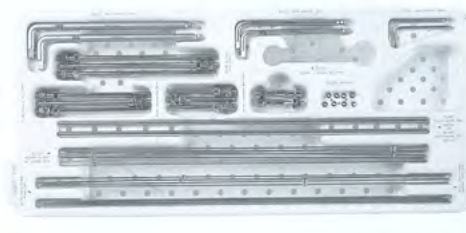
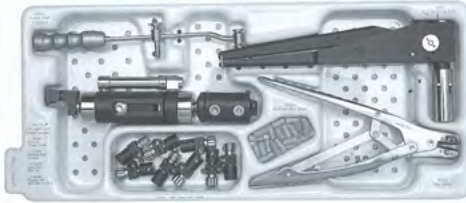

- 7100-0109-001 2x30017Two-Hole X-Wire Securing Pin Three-Hole Wire Clamp
- 7100-0109-002 Slider Unit
- 7100-0109-003 Wire Guide Wire Tensioner
- 7100-0109-004 Hybrid Fixator Standard Assembly Kit
- 7100-0109-005 Consisting of: 7 ProCallus Standard Central Body,
- 7100-0109-006 7 Compression-Distractor Unit Standard; 7 ProCallus Straight Clamp;
- 7100-0109-007 7 Hybrid Coupling with Ball-Joint. Wire Cutter
- 7100-0109-008 Supplementary Screw Holder Clamp
- 7100-0109-009 X-Wire Covers (pack of 20)
- 7100-0109-010 Allen Wrench 6 mm Allen Wrench 5 mm
- 7100-0109-011 RadioLucent Rings (see p. 36)
- 7100-0109-012 Lower Tray (Generic)
- 7100-0109-013 2x80035 Sheffield Clamp
- 7100-0109-014 2x80074 Single Screw Clamp
- 7100-0109-015 3x80047 Reduction Unit
- 7100-0109-016 3x11137 Screw Guide, length 80 mm
- 7100-0109-017 3x 11103 Screw Guide, length 100 mm
- 7100-0109-018 1x 11105 Drill Guide 0 4.8 mm, length 80 mm
- 7100-0109-019 1x 11138 Drill Guide 0 4.8 mm, length 60 mm
- 7100-0109-020 1x80034 Bolts 60 mm (set of 3)
- 7100-0109-021 1x80036 Threaded Bars,length 80 mm (set of 3)
- 7100-0109-022 1x80037 Threaded Bars,length 120 mm (set of 3)
- 7100-0109-023 1x80038 Threaded Bars,length 160 mm (set of 3)
- 7100-0109-024 1x80039 Threaded Bars,length 200 mm (set of 3)
- Upper Tray
- 7100-0109-025 Allen Wrench 3 mm Independent Wire Clamp Post, length 50 mm
- 7100-0109-026 Post, length 100 mm Post, length 150 mm
- 7100-0109-027 F.F.S. Large Washers (pack of 4) Supplementary Screw
- 7100-0109-028 Holder Bar 0 6 mm, •
- 7100-0109-029 Wire Tensioner
- 7100-0109-030 Ring Locking Screw
- 7100-0109-031 Two-Hole X-Wire Securing Pin Hybrid Fixator Short Assembly Kit
- 7100-0109-032 Consisting of:- 7 ProCallus Straight Clamp,
- 7100-0109-033 7 ProCallus Short Central Body, 7 Compression
- 7100-0109-034 Supplementary Screw Holder Bar 0 6 mm, length 400 mm X-Wire with lateral olive
- 7100-0109-035 0 2 mm, length 400 mm X-Wire with central olive 0 2 mm, length 400 mm X-Wire with central olive 0 2 mm, length 450 mm X-Wire without olive
- 7100-0109-036 0 2 mm, length 400 mm X-Wire without olive
- 7100-0109-037 0 2 mm, length 450 mm

Circular External Fixator (Adult) Instrument Set



- 7100-0018-001 Hybrid External Fixator (For Adaptation to External Circular Fixation System)
- 7100-0018-002 T-Wrench
- 7100-0018-003 Wrench with Open-Circular Ends
- 7100-0018-004 Hexagonal Wrench
- 7100-0018-005 Wrench with two Open Ends
- 7100-0018-006 Osteotome
- 7100-0018-007 Wire Cutter
- 7100-0018-008 Double Ended Offset Socket Wrench
- 7100-0018-009 Wire Tensioner
- 7100-0018-010 Wire Tightener
- 7100-0018-011 Sleeve Guide
- 7100-0018-012 Wire Tensioner
- 7100-0018-013 Drill Guide
- 7100-0018-014 Drill Guide without Handle
- 7100-0018-015 Adjustable Wrench
- 7100-0018-016 Adjustable Wrench End Piece

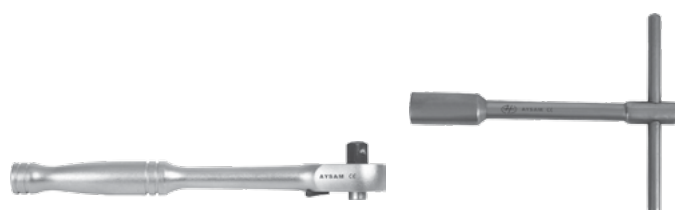
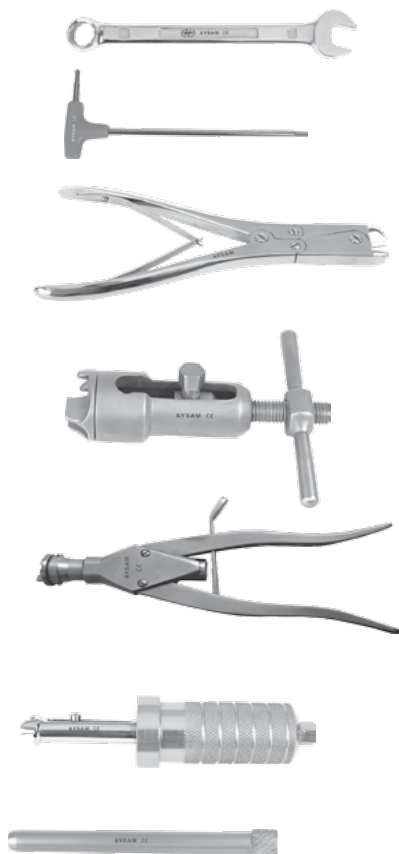

Circular External Fixator (Pediatric) Instrument Set

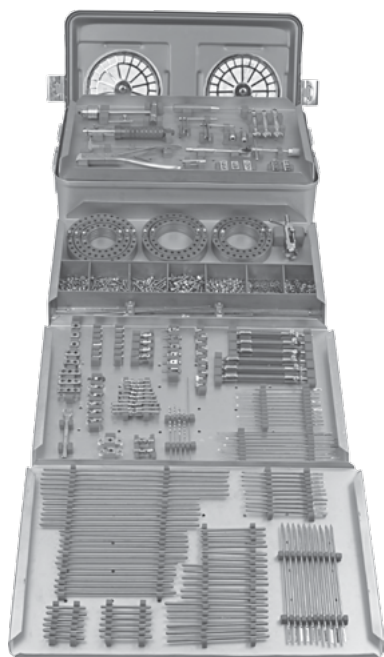

7100-0020-001 Hybrid External Fixator (For Adaptation to External Circular Fixation System)

7100-0020-002 T-Wrench

7100-0020-003 Wrench with Open-Circular Ends

7100-0020-004 Hexagonal Wrench

7100-0020-005 Wrench with two Open Ends

7100-0020-006 Osteotome

7100-0020-007 Wire Cutter

7100-0020-008 Double Ended Offset Socket

7100-0020-009 Wrench

7100-0020-010 Wire Tensioner

7100-0020-011 Wire Tightener

7100-0020-012 Sleeve Guide

7100-0020-013 Wire Tensioner

7100-0020-014 Drill Guide

7100-0020-015 Drill Guide without Handle

7100-0020-016 Adjustable Wrench

7100-0020-017 Adjustable Wrench End Piece



Wire Pin Instrument Set



- 7100-0021-001 Drill Guide
- 7100-0020-002 391.885 x1--Forceps
- 7100-0020-003 Depth Gauge
- 7100-0020-004 Plier
- 7100-0020-005 Screw driver



Cable-crim Block Instrument Set

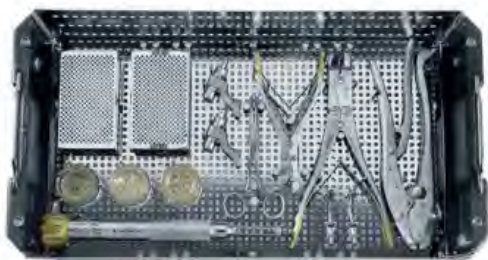

- 690.013 x1--Sterilization Case
- 391.883 x4--Attachment Bits
- 391.201 x2--Cable Tensioner
- 391.103 x1--Medium Cable Passer-Curved
- 391.104 x1--Large Cable Passer-Curved
- 391.107 x1--Large Cable Passer
- 391.108 x1--Large Cable Passer-45°
- 391.105 x1--Medium cable Passer
- 391.885 x1--Forceps
- 391.884 x4--Provisional Tensioning Devices
- 391.919 x1--Cable Tensioner
- 391.882 x1--Cable Crimper
- 391.906 x1--Cable Cutter-Large
- 391.905 x1--Cable Cutter-Standard

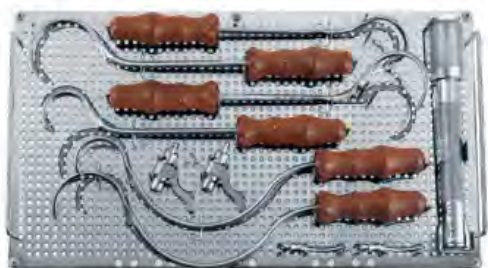

IMPLANTS INTERNATIONAL

8 Rue Richelieu
34300 Agde

France

☎ +33 4 67 30 34 32

☎ +33 6 86 58 31 12

✉ gvincent@implants-international.fr
mmekhalfa@implants-international.fr



Implants | International